

DX 345, DX 346, DX 347, DX 348

Universal Display Units with Impulse Inputs



| | |
|----------------|--|
| <u>DX 345:</u> | Display only |
| <u>DX 346:</u> | Display with Analogue Output |
| <u>DX 347:</u> | Display with Two Presets and Switching Outputs |
| <u>DX 348:</u> | Display with Serial Interface |

Operation modes:

- High Speed Position and Event Counter (100 kHz)
- Tachometer, Frequency Meter
- Baking Time and Processing Time Indicator (reciprocal speed)
- Timer, Stopwatch
- Speed Display from Transition Time between Start and Stop Impulse
- Additional Functions: Linearization, Brightness Control, Digital Filter etc.

Operating Instructions



Safety Instructions

- This manual is an essential part of the unit and contains important hints about function, correct handling and commissioning. Non-observance can result in damage to the unit or the machine or even in injury to persons using the equipment!
- The unit must only be installed, connected and activated by a qualified electrician
- It is a must to observe all general and also all country-specific and application-specific safety standards
- When this unit is used with applications where failure or maloperation could cause damage to a machine or hazard to the operating staff, it is indispensable to meet effective precautions in order to avoid such consequences
- Regarding installation, wiring, environmental conditions, screening of cables and earthing, you must follow the general standards of industrial automation industry
- - Errors and omissions excepted –

| Version: | Description |
|-----------------------|--|
| DX34502/af/hk/July 03 | Supplements for DX348 serial interface |
| DX34503/af/hk/Jan. 04 | Range extensions and supplements for serial code |
| DX34504/hk/hk/Jan. 07 | Version with 3 keys, A5 brochure, SV006, TTLIN, serial Reset |
| DX34508c/hk/hk/Mar08 | Small modifications only |
| DX34509a/hk/kk/Jun09 | Linearization, Manual Printing |
| DX34509b/sm/pp/Nov.11 | Chapter 4.3 supplemented by "Response time of analogue output" |

Table of Contents

| | | |
|-----------|---|-----------|
| 1. | Electrical Connections | 4 |
| 1.1. | Power Supply | 5 |
| 1.2. | Aux. Voltage Output | 5 |
| 1.3. | Inputs A, B and Reset | 5 |
| 1.4. | Adjustable Analogue Output (DX 346 only) | 6 |
| 1.5. | Optocoupler / Transistor Outputs (DX 347 only) *) | 6 |
| 1.6. | Serial RS232 / RS485 interface (DX 348 only)..... | 7 |
| 2. | How to Operate the Front Keys | 8 |
| 2.1. | Normal Display State | 8 |
| 2.2. | Selection and Setting of Parameters | 9 |
| 2.2.1. | How to select a parameter..... | 9 |
| 2.2.2. | How to change parameter settings | 9 |
| 2.2.3. | How to store settings | 9 |
| 2.2.4. | Time-Out Function | 9 |
| 2.3. | Teach Operation | 10 |
| 2.4. | Set All Registers to "Default" | 10 |
| 2.5. | Code Locking of the Keypad | 10 |
| 3. | The Operator Menu | 11 |
| 3.1. | Overview of Basic Parameters | 11 |
| 3.2. | Overview of Operational Parameters | 12 |
| 4. | Setup Procedure | 13 |
| 4.1. | Basic Settings | 13 |
| 4.2. | Operational Parameters..... | 15 |
| 4.2.1. | RPM, operation as tachometer or frequency counter..... | 15 |
| 4.2.2. | Time, display of baking or processing time (reciprocal speed)..... | 16 |
| 4.2.3. | Timer, Stopwatch..... | 17 |
| 4.2.4. | Count, Counter mode..... | 18 |
| 4.2.5. | Speed from differential time between a Start and a Stop input | 20 |
| 4.2.6. | Linearization points | 20 |
| 4.3. | Model DX 346: Additional Settings for the Analogue Output..... | 21 |
| 4.4. | Model DX 347: Additional settings for Preselections | 23 |
| 4.5. | Model DX 348: Additional Settings for the Serial Interface | 25 |
| 4.5.1. | PC-Mode..... | 27 |
| 4.5.2. | Printer-Mode..... | 29 |
| 5. | Special Functions | 30 |
| 5.1. | Linearization | 30 |
| 5.2. | Manual Input or „Teaching“ of the Interpolation Points | 32 |
| 6. | Technical Appendix | 34 |
| 6.1. | Dimensions | 34 |
| 6.2. | Technical Specifications..... | 35 |
| 6.3. | Parameter-List | 36 |
| 6.3.1. | General..... | 36 |
| 6.3.2. | Linearization..... | 37 |
| 6.3.3. | Analogue Output (DX 346)..... | 38 |
| 6.3.4. | Preselections (DX 347)..... | 38 |
| 6.3.5. | Serial interface (DX 348) | 38 |
| 6.4. | Commissioning Form | 39 |

1. Electrical Connections

DX345:

Display unit only

Special versions with TTL inputs (option TTLIN1) provide a +5V aux. output on terminal 7, instead of +24V

Units with option SV006 provide 24 / 42 VAC power input instead of 115 / 230 VAC

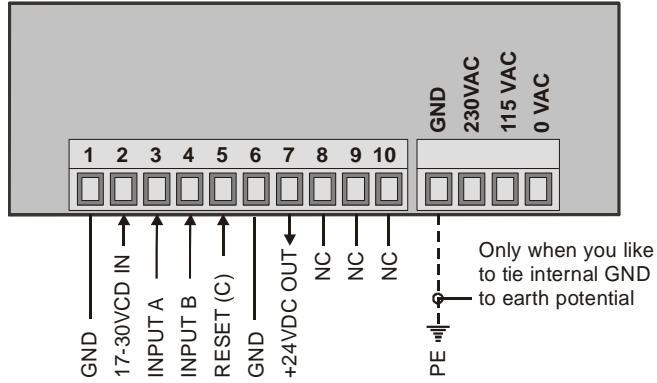

DX 346:

Display unit with analogue output

Special versions with TTL inputs (option TTLIN1) provide a +5V aux. output on terminal 7, instead of +24V

Units with option SV006 provide 24 / 42 VAC power input instead of 115 / 230 VAC

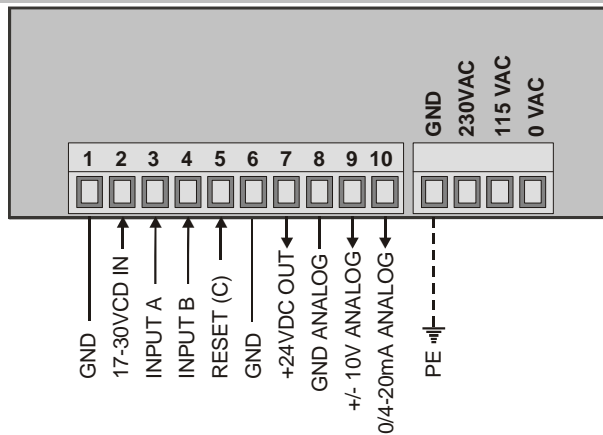

DX347:

Display unit with 2 presets and transistor outputs

Special versions with TTL inputs (option TTLIN1) provide a +5V aux. output on terminal 7, instead of +24V

Units with option SV006 provide 24 / 42 VAC power input instead of 115 / 230 VAC

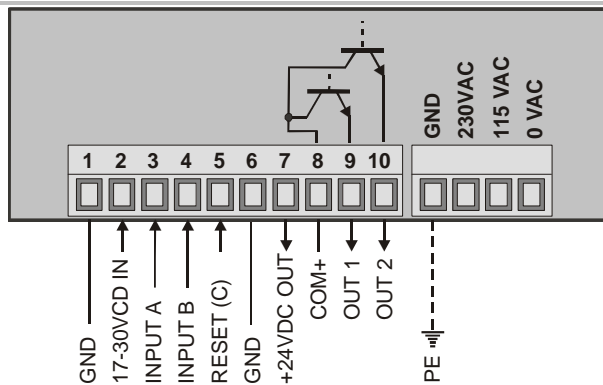

DX348:

Display unit with serial interface

Special versions with TTL inputs (option TTLIN1) provide a +5V aux. output on terminal 7, instead of +24V

Units with option SV006 provide 24 / 42 VAC power input instead of 115 / 230 VAC

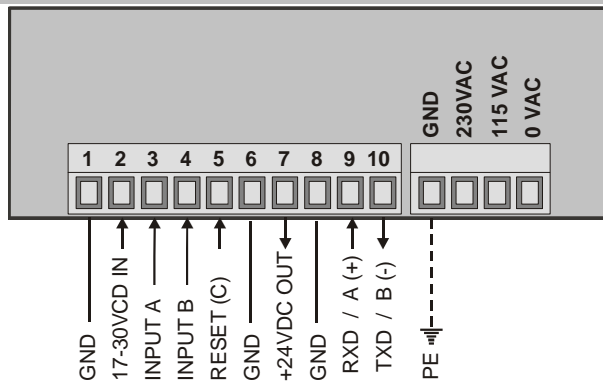

1.1. Power Supply

The unit accepts DC supply from 17 V to 30 V when using terminals 1 and 2, and the consumption depends on the level of the supply voltage (typically between 80 mA and 150 mA plus current taken from aux. output).

For AC supply, terminals 0 VAC, 115 VAC or 230 VAC can be used. The total AC power consumption is 7.5 VA.

Units with option "SV006" are prepared for AC supply with 24 VAC or 42 VAC and the screw terminals are marked correspondingly.

The diagrams show a dotted line for grounding to PE. This connection is not necessary, neither for safety nor for EMC. However, with specific applications, it can be useful to ground the common potential of all signal lines.



When using this earthing option, please observe:

- All terminals and potentials marked "GND" will be earthed.
- You should avoid multiple earthing, e.g. when you use a DC power supply where the Minus is already connected to earth etc. Especially under poor earthing and grounding conditions, multiple earth connections may cause serious EMC problems.

1.2. Aux. Voltage Output

Terminal 7 provides an auxiliary output of 24 VDC / 120 mA max. for supply of sensors and encoders. Units with TTL inputs (option TTLIN1) provide a 5 VDC / 120 mA auxiliary output on terminal 7 instead.

1.3. Inputs A, B and Reset

In the basic setup menu these inputs can be configured to PNP (switch to +) or to NPN (switch to -). This configuration is valid for all three inputs at a time.

The factory setting is always PNP.

With standard units the input level is always HTL (Low <2.0 V and High >9.0 V)

Units equipped with option TTLIN1 provide TTL / CMOS) level (Low <0.8 V and High >3.5 V)



- Independent of your setting, all functions of the unit are "active HIGH" and the unit triggers to positive transitions (rising edge).
- With NPN setting please be aware that an open or unused RESET input is HIGH. Therefore the unit will be kept in a continuous RESET state and will not work, unless you tie the Reset line to GND (terminal 1 or 6)
- Where your use 2-wire NAMUR type sensors, please select NPN, connect the negative wire of the sensor to GND and the positive wire to the corresponding input.

Typical input circuit (standard version with HTL inputs):

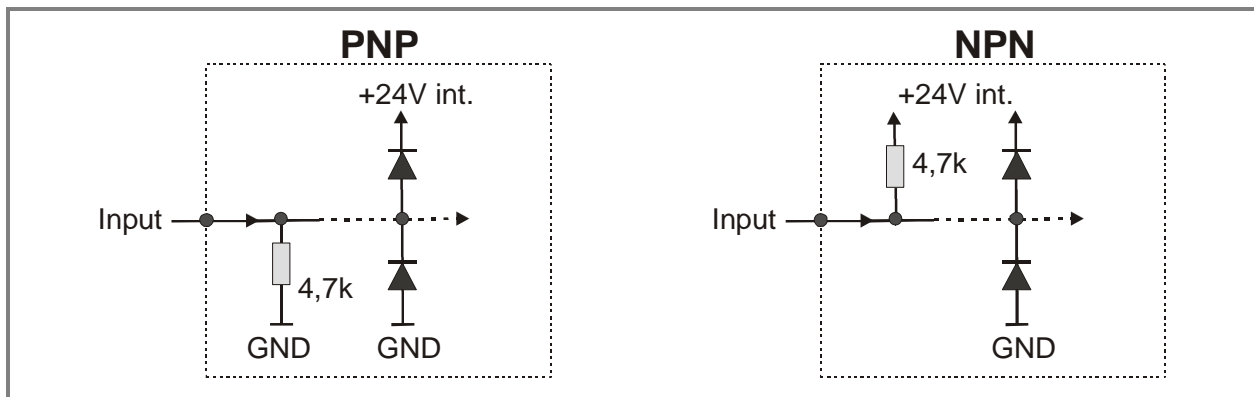

The counting inputs A and B are designed for input frequencies up to 100 kHz (with all counter modes) and up to 25 kHz (with all other operating modes).

The minimum pulse duration on the Reset input must be 500 µsec. (maximum frequency 1 kHz) All inputs are designed to receive impulses from an electronic impulse source. Where exceptionally you need to **use mechanical contacts**, please connect an external capacitor between GND (-) and the corresponding input (+). With a capacity of 10 µF, the maximum input frequency will reduce to 20 Hz and miscounting due to contact bouncing will be eliminated.

1.4. Adjustable Analogue Output (DX 346 only)

A voltage output is available, operating in a range of 0...+10 V or -10 V...+10 V according to setting. At the same time, a current output 0/4 – 20 mA is available. Both outputs refer to the GND potential and the signal polarity changes with the sign in the display. The outputs provide a 14 bits resolution and the response time to changes of the measuring value is approx. 7 msec. ($f_{in} > 143$ Hz)

The maximum current of the voltage output is 2 mA, and the load on the current output can vary between 0 and max. 270 ohms.

1.5. Optocoupler / Transistor Outputs (DX 347 only) *)

The outputs provide programmable switching characteristics and are potential-free. Please connect terminal 8 (COM+) to the positive potential of the voltage you like to switch (range 5V...30V). You must not exceed the maximum output current of 150 mA. Where you switch inductive loads, please provide filtering of the coil by means of an external diode.

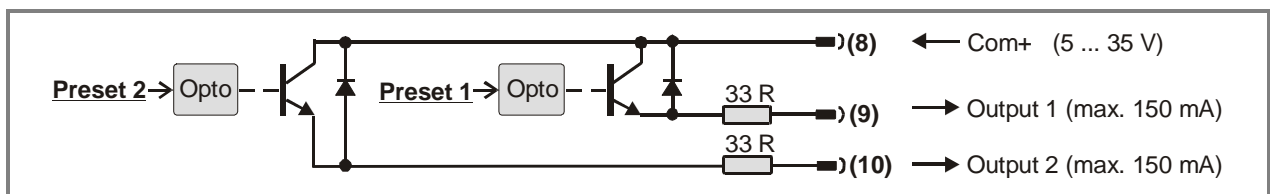

*) For relay outputs please refer to model DX342

1.6. Serial RS232 / RS485 interface (DX 348 only)

Ex factory the unit is set to RS232 communication. This setting can be changed to RS485 (2-wire) by means of an internal DIL switch. To access the DIL switch, please remove the screw terminal connectors and the backplane. Then pull the print to the rear to remove the PCB from the housing.

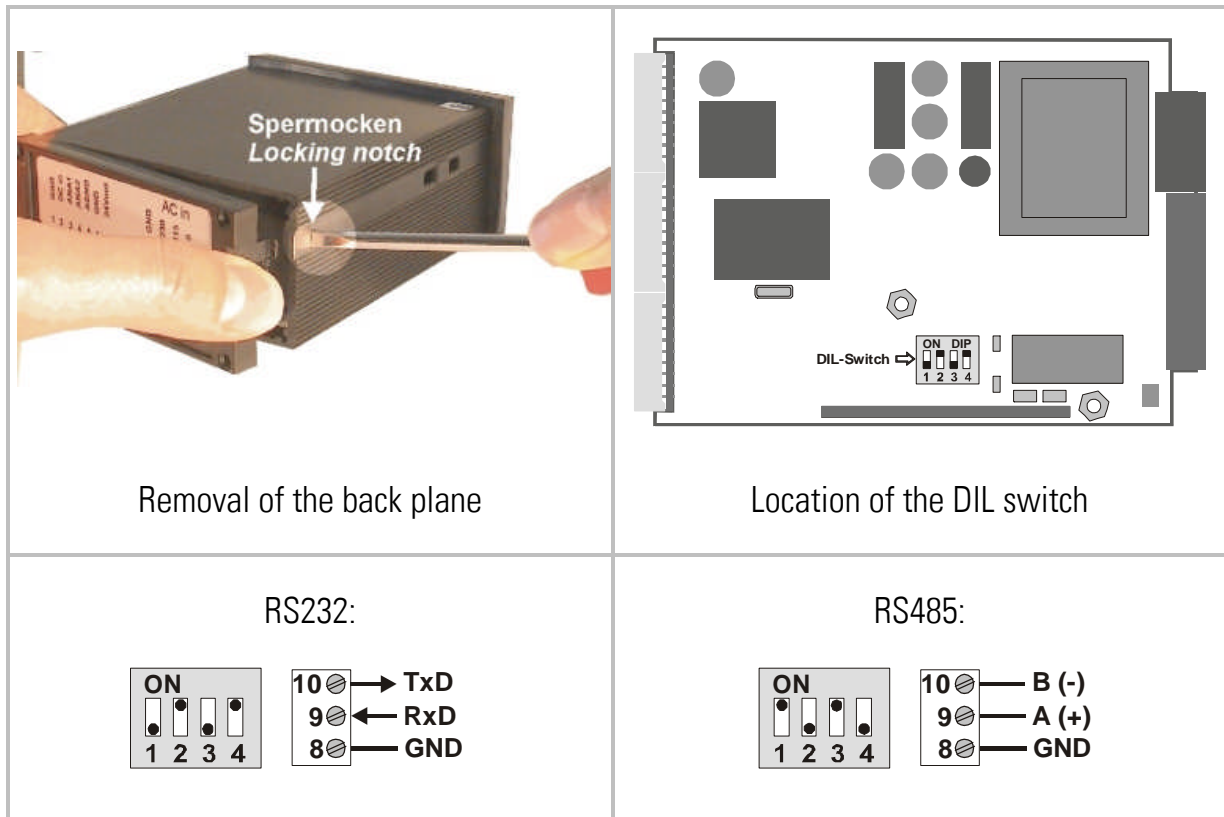

- Never set DIL switch positions 1 and 2 or DIL switch positions 3 and 4 to ON at the same time!
- After setting the switch, shift the print carefully back to the housing, in order to avoid damage of the front pins for connection with the front plate.

2. How to Operate the Front Keys

For setup and other operations the unit uses three front keys which subsequently will be denominated as follows:

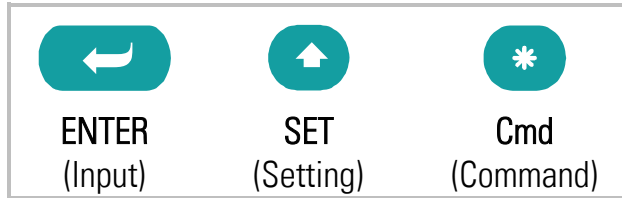

The functions of the keys are depending on the actual operating state of the unit. The following three operating states apply:

- Normal display state
- Setup state
 - a.) Basic setup
 - b.) Operational parameter setup
- Teach operation

2.1. Normal Display State



You can only change over to other operation states while the unit is in display state.

| Change over to | Key operation |
|-----------------------------|--|
| Basic setup | Keep ENTER and SET down simultaneously for 3 seconds |
| Operational parameter setup | Keep ENTER down for 3 seconds. |
| Teach operation | Keep Cmd down for 3 seconds |

The Cmd key is only used to execute the Teach procedure with linearization. For more details please refer to sections 5.1 and 5.2.

2.2. Selection and Setting of Parameters

2.2.1. How to select a parameter

The **ENTER** key will scroll through the menu. The **SET** key allows to select the corresponding item and to change the setting or the numeric value. After this, the selection can be stored by **ENTER** again, which automatically changes over to the next menu item.

2.2.2. How to change parameter settings

With numerical entries, at first the lowest digit will blink. When keeping the **SET** key continuously down, the highlighted digit will scroll in a continuous loop from 0 ... 9, 0 ... 9. After releasing the **SET** key, the actual value will remain and the next digit will be highlighted (blink). This procedure allows setting of all digits to the desired values. After the most significant digit has been set, the low order digit will blink again and you can do corrections if necessary.

With signed parameters, the high order digit will scroll from "0" to "9" (positive) followed by "-" and "-1" (negative)

2.2.3. How to store settings

To store the actual setting, press the **ENTER** key, which will also automatically scroll forward the menu.

At any time the unit changes from programming mode to normal display operation, when you keep the **ENTER** key down again for at least 3 seconds.

2.2.4. Time-Out Function

A "time-out" function will automatically conclude every menu level, when for a break period of 10 seconds no key has been touched. In this case, all changes which have not been confirmed by **ENTER** yet would remain unconsidered.

2.3. Teach Operation



The Time-Out Function remains disabled during all Teach operations

| Key | Function |
|-----|--|
| | ENTER will conclude or abort any Teach operation in progress |
| | SET function is fully similar to normal set-up operation |
| | Cmd will store the display value to the register and will change over to the next interpolation point. |

For details of the Teach procedure see section 5.2.

2.4. Set All Registers to “Default”

At any time you can return all settings to the factory default values.



This action will reset all parameters to factory default values and your own settings will be lost. You will have to repeat your individual setup procedure. Factory default values are shown in the subsequent parameter tables.

To reset the unit to default values:

- switch power off
- press the **ENTER** key on the front
- keep **ENTER** down while you power up again

2.5. Code Locking of the Keypad

When the code locking of the keypad has been switched on, any key access first results in display of



To access the menu you must press the key sequence



within 10 seconds, otherwise the unit will automatically return to the normal display mode.

3. The Operator Menu

The menu provides one section with "Basic Parameters" and another section with "Operational Parameters". On the display you will only find those parameters which have been enabled by the basic settings. E.g. when the Linearisation Function has been disabled in the basic set-up, the associated linearization parameters will also not appear in the parameter menu.

All parameters, as good as possible, are designated by text fragments. Even though the possibilities of forming texts are very limited with a 7-segment display, this method has proved to be most suitable for simplification of the programming procedure.

The subsequent table shows the general structure of the menu. Detailed descriptions of all parameters will follow in section 4.

3.1. Overview of Basic Parameters

| DX345 | DX346 | DX347 | DX348 |
|---|---|---|---|
| Type (Application Mode) Input Characteristics Brightness Code Linearization Mode *) | Type (Application Mode) Input Characteristics Brightness Code Linearization Mode *) | Type (Application Mode) Input Characteristics Brightness Code Linearization Mode *) | Type (Application Mode) Input Characteristics Brightness Code Linearization Mode *) |
| | Analogue Output Mode | Preselection Mode 1 | Serial Unit Number |
| | Analogue Offset | Preselection Mode 2 | Serial Format |
| | Analogue Gain | Hysteresis 1 | Serial Baud Rate |
| | | Hysteresis 2 | |

*) Appears only with Modes "RPM" and "Count"

3.2. Overview of Operational Parameters

| | Mode "RPM" (Tachometer) | Mode "Time" (Baking Time) | Mode "Timer" (Stopwatch) | Mode "Count" (Counter) | Mode "Speed" (Transition speed) | |
|------------------|-------------------------------|---------------------------------|--------------------------------|------------------------------|---------------------------------------|--|
| DX345 | Frequency | Display Format | Base (Resolution) | Counter Mode | Time | |
| | Display Value | Frequency | Start/Stop | Scaling Factor | Display Value | |
| | Decimal Point | Decimal Value | Auto Reset | Set Value | Decimal Point | |
| | Wait Time | Wait Time | Latch Function | Reset/Set | Wait Time | |
| | Average Filter | Average Filer | | Decimal Point | | |
| DX346 | Frequency | Display Format | Base (Resolution) | Counter Mode | Time | |
| | Display Value | Frequency | Start/Stop | Scaling Factor | Display Value | |
| | Decimal Point | Decimal Value | Auto Reset | Set Value | Decimal Point | |
| | Wait Time | Wait Time | Latch Function | Reset/Set | Wait Time | |
| | Average Filter | Average Filer | | Decimal Point | | |
| | Analogue Begin | | | | | |
| | Analogue End | | | | | |
| DX347 | Preselection 1 | | | | | |
| | Preselection 2 | | | | | |
| | Frequency | Display Format | Base (Resolution) | Counter Mode | Time | |
| | Display Value | Frequency | Start/Stop | Scaling Factor | Display Value | |
| | Decimal Point | Decimal Value | Auto Reset | Set Value | Decimal Point | |
| | Wait Time | Wait Time | Latch Function | Reset/Set | Wait Time | |
| | Average Filter | Average Filer | | Decimal Point | | |
| DX348 | Frequency | Display Format | Base (Resolution) | Counter Mode | Time | |
| | Display Value | Frequency | Start/Stop | Scaling Factor | Display Value | |
| | Decimal Point | Decimal Value | Auto Reset | Set Value | Decimal Point | |
| | Wait Time | Wait Time | Latch Function | Reset/Set | Wait Time | |
| | Average Filter | Average Filer | | Decimal Point | | |
| | Serial Timer | | | | | |
| | Serial Mode | | | | | |
| | Serial Code | | | | | |
| All units | P01_H(*) | | | P01_H(*) | | |
| | P01_Y(*) | | | P01_Y(*) | | |
| | .. | | | .. | | |
| | P16_H(*) | | | P16_H(*) | | |
| | P16_Y(*) | | | P16_Y(*) | | |

*) Appears only with modes "RPM" and "Count" when the linearization function has been enabled

4. Setup Procedure

For better understanding the following sections 4.1 and 4.2 explain settings related to the display only. Model-specific settings for Analogue Output, Preselections and Serial Link will be explained separately under sections 4.3 to 4.5, later.

4.1. Basic Settings

These settings in general have to be carried out one time only upon the very first use of the unit. The basic setup selects the desired operation mode of the unit, the input characteristics PNP/NPN and the desired brightness of the LED display.



To access the Basic Setup press ENTER and SET simultaneously for at least 3 seconds.

| Menu | | Setting Range | Default |
|----------------|--|---|----------------------------------|
| TYPE | Operation Mode: Tachometer, frequency meter (4.2.1) Baking time / processing time indicator (4.2.2) Timer, Stopwatch (4.2.3) Counter for position or event (4.2.4) Speed calculation from differential transition time (4.2.5) | <input type="text" value="rPn"/> <input type="text" value="t. rE"/> <input type="text" value="t. rEr"/> <input type="text" value="Count"/> <input type="text" value="SPEED"/> | <input type="text" value="rPn"/> |
| CHAR | Switching characteristics of the inputs: NPN, switch to "-" PNP, switch to "+" | <input type="text" value="nPN"/> <input type="text" value="PNP"/> | <input type="text" value="PNP"/> |
| br. Ght | Brightness of the LED display: | 20%, 40%, 60%, 80%, 100% | 100% |









| Menu | | Setting Range | Default |
|---------------|--|---|---------------------------------|
| Code | Keypad protection code: Keypad enabled continuously Keypad locked for any access Keypad locked, except for access to preselections Pres 1 und Pres 2 (DX 347 only) | <input type="text" value="no"/> <input type="text" value="ALL"/> <input type="text" value="P.FrEE"/> | <input type="text" value="no"/> |
| LinERr | Linearization Mode: *) For details please refer to 5.1 and 5.2 The linearization is switch off. Linearization settings for the positive range only (negative values will appear as a mirror). Linearization over the full numeric range | <input type="text" value="no"/> <input type="text" value="1-9UR"/> <input type="text" value="4-9UR"/> | <input type="text" value="no"/> |

*) with Tachometer mode and Counter mode only

4.2. Operational Parameters

4.2.1. RPM, operation as tachometer or frequency counter

(Input A = frequency input, Input B not in use)

| Menu | | Setting Range | Default |
|---|--|--|---|
|  | Frequency: Set a typical operating frequency for your application. | 1 Hz to 25 000 Hz | 1000 |
|  | Display Value: Set the value you would like to see on your display with above frequency at the input. | 1 ... 99999 | 1000 |
|  | Decimal Point: Select the desired position like shown in the display. no decimal point decimal point at position 1 ----> decimal point at position 5 | 000000 00000.0 0.00000 | 000.000 |
|  | Wait Time: Define a "waiting time", this is the time in seconds that the unit will wait from one input pulse to the next, before it sets the display to zero. When you enter "0", the unit will wait forever and show the last result until it receives the next input.  The setting of this parameter automatically limits the minimum input frequency correspondingly. With "Wait" set to e.g. 0.1 sec. the unit will respond to frequencies > 10 Hz only and all lower frequencies will just display 0. | 0.1 ... 99.9 sec | 1.0 |
|  | Average Filter: Selectable average filter to suppress unstable display with unsteady input frequencies. No filtering 2, 4, 8, 16 = number of floating average cycles. |   |  |



Model DX346 also provides a signed speed display with the +/- sign changing according to the direction of rotation (see 4.3.).

4.2.2. Time, display of baking or processing time (reciprocal speed)

(Input A = frequency input, Input B not in use)

| Menu | | Setting Range | Default |
|--------------------|--|--|--|
| d ,SFor | Display Format: Select between seconds, minutes, minutes and seconds or minutes with two decimal positions. This will also automatically set your decimal point to the proper place. Seconds Minutes Minutes and seconds Minutes with two decimal positions | <div style="border: 1px solid black; padding: 2px; display: inline-block;">SEC</div> <div style="border: 1px solid black; padding: 2px; display: inline-block;">m n</div> <div style="border: 1px solid black; padding: 2px; display: inline-block;">m n .SE</div> <div style="border: 1px solid black; padding: 2px; display: inline-block;">m n .00</div> | <div style="border: 1px solid black; padding: 2px; display: inline-block;">SEC</div> |
| F r E q u | Frequency: Set a typical operating frequency for your application. | 1 Hz to 25 000 Hz | 100 |
| d ,SPL | Display Value: Set the value you would like to see on your display with above frequency at the input. | 1 ... 999999 | 100 |
| LWA it | Wait Time: Define a "waiting time", this is the time in seconds that the unit will wait from one input pulse to the next, before it sets the display to zero. When you enter "0", the unit will wait forever and show the last result until it receives the next input.  The setting of this parameter automatically limits the minimum input frequency correspondingly. With "Wait" set to e.g. 0.1 sec. the unit will respond to frequencies > 10 Hz only and all lower frequencies will just display 0. | 0.1 ... 99.9 s | 5.0 |
| F i l t e r | Average Filter Selectable averages filter to suppress unstable display with unsteady input frequencies. No filtering 2, 4, 8, 16 = number of floating average cycles. | <div style="border: 1px solid black; padding: 2px; display: inline-block;">OFF</div> <div style="border: 1px solid black; padding: 2px; display: inline-block;">16</div> | <div style="border: 1px solid black; padding: 2px; display: inline-block;">OFF</div> |

4.2.3. Timer, Stopwatch

Please note that open NPN inputs are always "HIGH" and open PNP inputs are always "LOW".

| Menu | | Setting Range | Default |
|--------------|---|--|---------------|
| BASE | Time base / Resolution of the timer: Milliseconds 1/100 seconds 1/10 seconds Integer seconds Minutes with two decimal positions Minutes with one decimal position Hours : minutes : seconds | SECO00 SECO0 SECO SEC mm.00 mm.0 H-mm-S | SECO00 |
| StArt | Start/Stop of time measurement: Time count is active while input A is HIGH. Rising edge on input A starts count. Rising edge on input B stops count. Period time measurement. Repeating display of the time between two rising edges on input A | H.Loo St_SP A.StSP | St_SP |
| rESEt | Auto Reset: Time count cumulates with every new start. No automatic Reset. Use the Reset input to set to zero. Every start initializes a new count starting from zero. | no YES | no |
| LAtch | Latch Function: Real time display, count visible. Frozen display of the final count result after every Stop. The timer counts in the background, | no YES | no |

4.2.4. Count, Counter mode

| Menu | | Setting Range | Default |
|----------------|---|---|---------------|
| mode | Counting Mode: Input A counts and input B selects the counting direction (LOW = increment, HIGH = decrement) Summing counter, A + B Differential counter, A – B Quadrature up/down counter A/B with single edge count (x1) Quadrature up/down counter A/B with double edge count (x2) Quadrature up/down counter A/B with (x4) edge count. | A_b d r A u b A - b A_b .1 A_b 2 A_b 4 | A_b .1 |
| Factor | Impulse Scaling Factor: Example: setting 1.2345 results in display of 12 345 after 10 000 input pulses. | 0.0001 ... 9.9999 | 1.0000 |
| SET | Set Value: Every Reset signal will set the display to the value entered here | -199 999 ... 999 999 | 0 |
| rESEt | Reset/Set Enable: No setting or resetting of the counter is possible Set / Reset by the front SET key Set / Reset by remote signal to the Reset input. Set / Reset by front SET key and by external input. | no front E_tErn Fr u E | Fr u E |
| dPo int | Decimal Point: Select the desired position like shown in the display. no decimal point one decimal position ----> five decimal positions | 000000 00000.0 0.00000 | 000.000 |



- The counting range of the unit is limited from -199999 to 999999.
In case of underflow or overflow the unit will display 
- The counter stores all counting data also in power-down state (EEProm with data retention >10 years)
- With the summing mode (A+B) and the differential mode (A-B) please note that the impulse scaling factor will only affect input A

4.2.5. Speed from differential time between a Start and a Stop input

Input A operates as a start input and input B operates as a Stop input. The differential time between start and stop will be converted into the speed of the passing object.

| Menu | | Setting Range | Default |
|----------------|---|-------------------------------|-----------|
| Time | Time: Enter a typical delay time which you expect between the start and stop signals. | 000.001 ... 999.999 sec | 1.000 sec |
| d.SPL | Display Value: Enter the speed you would like to see in the display when an object passes within above time. | 000.001 ... 999.999 | 1.000 |
| dPo int | Decimal Point: Select the desired position like shown in the display. no decimal point done decimal position ----> five decimal positions | 000000 00000.0 0.00000 | 000.000 |
| LJA t | Wait Time How long should the last result remain in the display before it returns to zero? Set the desired waiting time. With setting "0" the display will freeze and wait until to the next measuring cycle. | 0.00 ... 9.99 | 1.00 |

4.2.6. Linearization points

The linearization points will only appear with Operation Modes "RPM" or "Count" when Linearization is enabled.

| Menu | | Setting Range | Default |
|-------|--|-----------------------|---------|
| P01_X | Linearization point 1: X value of the first interpolation point. | -199999 ... 999999 | 999999 |
| P01_Y | Linearization point 1: Y value of the first interpolation point. | -199999 ... 999999 | 999999 |
| | ... | | |
| | ... | | |
| P16_X | Linearization point 16: X value of the 16. interpolation point. | -199999 ... 999999 | 999999 |
| P16_Y | Linearization point 16: Y value of the 16. interpolation point. | -199999 ... 999999 | 999999 |

For more details about linearization please refer to section 5.

4.3. Model DX 346: Additional Settings for the Analogue Output

The Basic Menu provides the following additional settings:

| Menu | | Setting Range | Default |
|---------------|--|---|---------------|
| A-CHAR | Analogue Characteristics: Select one of the following options: +/-10 V (bipolar) 0-10 V (positive output only) 4-20 mA current output. 0-20 mA current output Where you set the output to +/-10 Volts, your input signals A/B must be of quadrature type with phase displacement. The polarity of the output follows the sign in the display (operation as a counter or as a speed display with detection of direction of rotation) | <div style="border: 1px solid black; padding: 2px; display: inline-block;">- 10 _ 10</div> <div style="border: 1px solid black; padding: 2px; display: inline-block;">0 _ 10</div> <div style="border: 1px solid black; padding: 2px; display: inline-block;">4 _ 20</div> <div style="border: 1px solid black; padding: 2px; display: inline-block;">0 _ 20</div> | 0 _ 10 |
| OFFSET | Analog Offset *): Set this register to "0" when your output range should begin at zero (or 4 mA) If you desire another initial output value, set this register correspondingly. Setting 5.000 means your output will start at 5 Volts instead of zero. | -9.999 ... +9.999 | 0.000 |
| GAIN | Analog Gain *): Set the analogue stroke you desire: Setting 1000 means 10 Volts or 20 mA. Setting 200 reduces the stroke to 2 Volts or 4 mA. | 00.00 ... 99.99 | 10.00 |

*) see next page for more details

Response time of the analogue output:

| Operation mode | Response time analogue output |
|---|---|
| Tachometer, frequency meter (4.2.1) | 330ms at f >3Hz 1/f at f < 3Hz |
| Baking time / processing time indicator (4.2.2) | 330ms at f >3Hz 1/f at f < 3Hz |
| Timer, Stopwatch (4.2.3) | 7 ms (With latch function after every measurement) |
| Counter for position or event (4.2.4) | Counter value + 7ms |
| Speed calculation from differential transition time (4.2.5) | Runtime + 7ms |

The analogue output behaves like the display output.

The following Operational Parameters provide scaling of the analogue output:

| Menu | | Setting Range | Default |
|---------------|---|--------------------|---------|
| AnAbEG | Analog-Begin: Start value of the analog output. | -199999 ... 999999 | 0 |
| AnAEnd | Analog-End: End value of the analog output. | -199999 ... 999999 | 10000 |

By means of these two parameters any window of the whole display range can be mapped onto the analogue output.

The subsequent example shows how to convert the display range from 1400 to 2200 into an analogue signal of 2 - 10 volts.

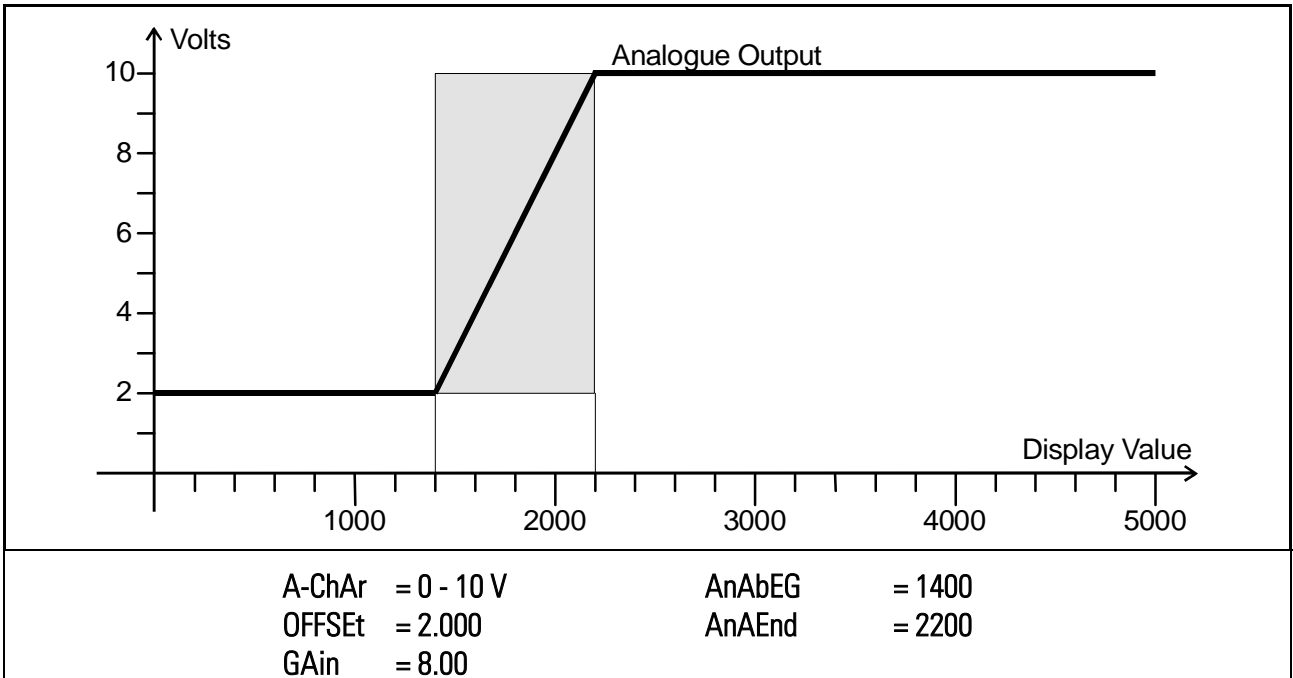

All settings refer to the scaled values which are shown in the display of the unit.

4.4. Model DX 347: Additional settings for Preselections

The basic setup menu provides the following additional parameters:

| Menu | | Default |
|---------------|--|---------------|
| CHAR 1 | Switching characteristics of output 1. | --r GE |
| | --r GE Greater/Equal: output to switch statically "ON" when display value \geq preset value. | |
| | --r LE Lower/Equal: output to switch statically "ON" when display value \leq preset value. | |
| | _n_ GE Greater/Equal: output to switch dynamically "ON" when display value \geq preset value. (timed pulse output *) | |
| | _n_ LE Lower/Equal: output to switch dynamically "ON" when display value \leq preset value. (timed pulse output *) | |
| | ∩-ES Reset: Timed impulse output *) and automatic Reset to zero when the display value reaches Preset 1. | |
| | _n_SEE Set: Timed impulse output *) and automatic setting to preset 1 when the display value reaches zero. | |
| CHAR 2 | Switching characteristics of output 2. | --r GE |
| | --r GE See Char 1 | |
| | --r LE See Char 1 | |
| | _n_ GE See Char 1 | |
| | _n_ LE See Char 1 | |
| | _J 1-2 Output switches statically ON when display value \geq <u>Preset 1 – Preset 2</u> **). | |
| | _n 1-2 Output switches dynamically ON when display value \geq <u>Preset 1 – Preset 2</u> **). | |
| HYS1 | Hysteresis 1: Adjustable hysteresis for output 1. (***) Setting range 0 ... 99999 display units | 0 |
| HYS2 | Hysteresis 2: Adjustable hysteresis for output 2, (***) Setting range 0 ... 99999 display units | 0 |

*) Fixed pulse duration of 500 msec (factory adjustable only)

***) This feature serves for generation of an anticipation signal with a fixed distance to the preset 1 signal. The anticipation automatically follows the setting of preset 1 (trailing preset).

****) Switching hysteresis is only active with "RPM" and "Time" operation

The following operational parameters provide setting of the switching points:

| Menu | | Setting Range | Default |
|---------------|-----------------|----------------------|---------|
| PrES_1 | Preselection 1: | -199999... 999999 | 10000 |
| PrES_2 | Preselection 2: | -199999... 999999 | 5000 |

The working direction of the Hysteresis depends on the setting of the switching characteristics. With settings „GE“ or „LE“ respectively, the following switch points will result:

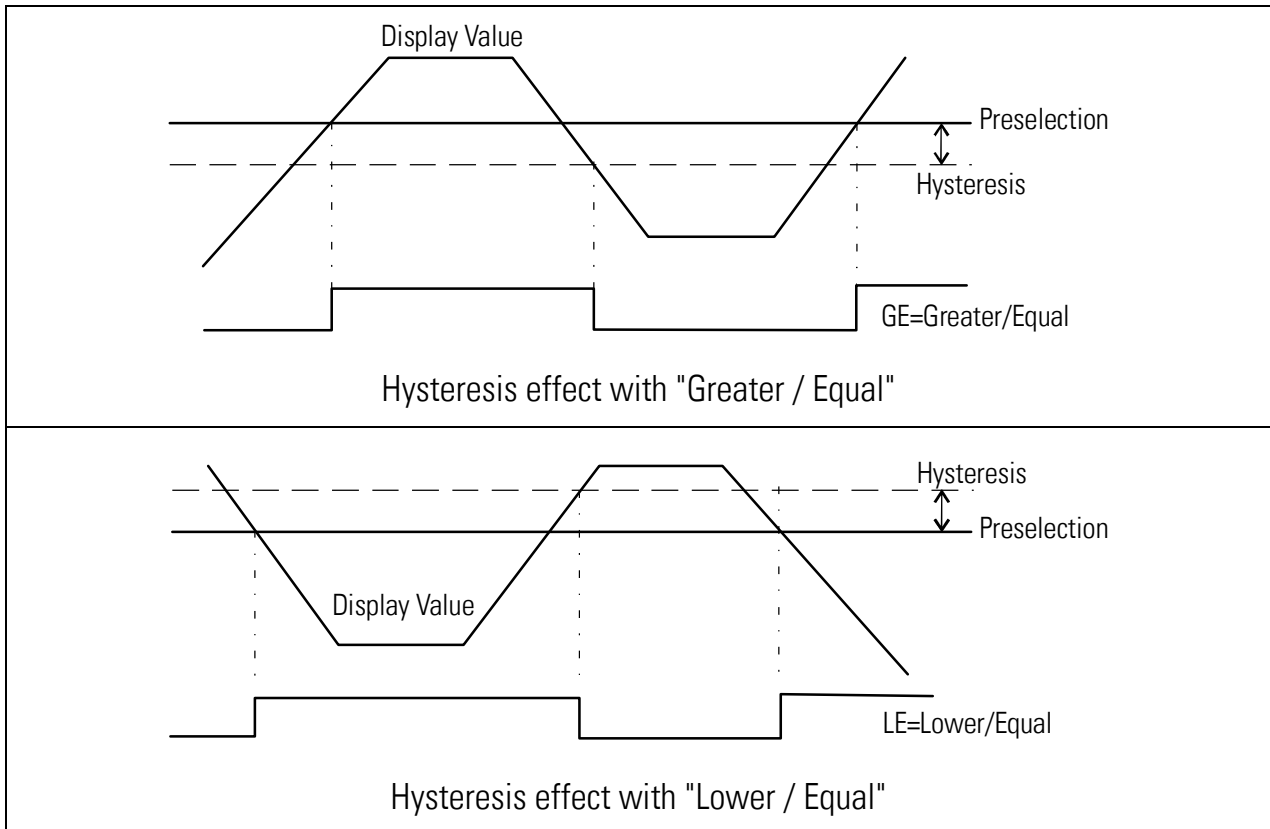

It is possible to check up on the actual switching state of the outputs at any time.

For this, just tap on the ENTER key shortly.

The display will then show for the next two seconds one of the following information:

| Display | Meaning |
|---------------|---|
| 1.2oFF | Both outputs are actually off. |
| 1.2oN | Both outputs are actually on. |
| 1 on | Output 1 is on. Output 2 is off. |
| 2on | Output 1 is off. Output 2 is on. |

4.5. Model DX 348: Additional Settings for the Serial Interface

The basic setup menu contains the main parameters for configuration of the serial interface

| Menu | Setting Range | Default |
|---|---|---------|
| S-Unit Serial Unit Number: You can assign any address number between 11 and 99 to your unit. The address must <u>not</u> contain a "0" because these numbers are reserved for collective addressing. | 0 ... 99 | 11 |
| S-Form Serial data format: The first character indicates the number of Data Bits. The second character specifies the Parity Bit ("even" or "odd" or "none") The third character indicates the number of Stop Bits. | <div style="display: flex; flex-direction: column; gap: 5px;"> <div style="border: 1px solid black; padding: 2px;">7 E 1</div> <div style="border: 1px solid black; padding: 2px;">7 E 2</div> <div style="border: 1px solid black; padding: 2px;">7 O 1</div> <div style="border: 1px solid black; padding: 2px;">7 O 2</div> <div style="border: 1px solid black; padding: 2px;">7 no 1</div> <div style="border: 1px solid black; padding: 2px;">7 no 2</div> <div style="border: 1px solid black; padding: 2px;">8 E 1</div> <div style="border: 1px solid black; padding: 2px;">8 O 1</div> <div style="border: 1px solid black; padding: 2px;">8 no 1</div> <div style="border: 1px solid black; padding: 2px;">8 no 2</div> </div> | 7 E 1 |
| S-bAUD Baud Rate: The adjoining Baud rates can be selected | <div style="display: flex; flex-direction: column; gap: 5px;"> <div style="border: 1px solid black; padding: 2px;">9600</div> <div style="border: 1px solid black; padding: 2px;">4800</div> <div style="border: 1px solid black; padding: 2px;">2400</div> <div style="border: 1px solid black; padding: 2px;">1200</div> <div style="border: 1px solid black; padding: 2px;">600</div> <div style="border: 1px solid black; padding: 2px;">19200</div> <div style="border: 1px solid black; padding: 2px;">38400</div> </div> | 9600 |

The following operational parameters provide setting of the communication profile:

| Menu | Setting Range | Default | | | | | | | | | | | | | | | | |
|---|---|---------------------------------|-------|----------------------|------|-----|---------------------|----|------|-------------------|------------|----|-------|----|-------|---|----------------------------------|----------------|
| <p>S-t in7 Serial Timer: Setting 0,000 allows manual activation of a serial data transmission at any time. All other settings specify the cycle time for automatic transmission (provided the Serial Mode is set to "Printer")</p> <p>Between two transmission cycles the unit will allow a pause depending on the baud rate. The minimum cycle times for timer transmissions are shown in the table.</p> <table border="1" data-bbox="375 645 933 943"> <thead> <tr> <th>Baud Rate</th> <th>Minimum Cycle Time [msec]</th> </tr> </thead> <tbody> <tr><td>600</td><td>384</td></tr> <tr><td>1200</td><td>192</td></tr> <tr><td>2400</td><td>96</td></tr> <tr><td>4800</td><td>48</td></tr> <tr><td>9600</td><td>24</td></tr> <tr><td>19200</td><td>12</td></tr> <tr><td>38400</td><td>6</td></tr> </tbody> </table> | Baud Rate | Minimum Cycle Time [msec] | 600 | 384 | 1200 | 192 | 2400 | 96 | 4800 | 48 | 9600 | 24 | 19200 | 12 | 38400 | 6 | 0.000; 0.010... 9..999 sec | 0.1 sec |
| Baud Rate | Minimum Cycle Time [msec] | | | | | | | | | | | | | | | | | |
| 600 | 384 | | | | | | | | | | | | | | | | | |
| 1200 | 192 | | | | | | | | | | | | | | | | | |
| 2400 | 96 | | | | | | | | | | | | | | | | | |
| 4800 | 48 | | | | | | | | | | | | | | | | | |
| 9600 | 24 | | | | | | | | | | | | | | | | | |
| 19200 | 12 | | | | | | | | | | | | | | | | | |
| 38400 | 6 | | | | | | | | | | | | | | | | | |
| <p>S-n7od Serial Mode: Operation according to communication profile (see 4.5.1) Transmission of string type 1 (see 4.5.2) Transmission of string type 2 (see 4.5.2)</p> | <input type="text" value="PC"/> <input type="text" value="Print1"/> <input type="text" value="Print2"/> | <input type="text" value="PC"/> | | | | | | | | | | | | | | | | |
| <p>S-CodeE Serial Register-Code: Specifies the register code of the data to be transmitted. The most important register codes are the actual display value and the serial Set/Reset command code</p> <table border="1" data-bbox="363 1395 1040 1514"> <thead> <tr> <th>Register</th> <th>S-Code</th> <th>ASCII</th> </tr> </thead> <tbody> <tr> <td>Actual display value</td> <td>101</td> <td>: 1</td> </tr> <tr> <td>Activate SET /RESET</td> <td>60</td> <td>6 0</td> </tr> </tbody> </table> | Register | S-Code | ASCII | Actual display value | 101 | : 1 | Activate SET /RESET | 60 | 6 0 | 100 ... 120 | 101 | | | | | | | |
| Register | S-Code | ASCII | | | | | | | | | | | | | | | | |
| Actual display value | 101 | : 1 | | | | | | | | | | | | | | | | |
| Activate SET /RESET | 60 | 6 0 | | | | | | | | | | | | | | | | |

4.5.1. PC-Mode

Communication with PC - Mode allows free readout of all parameters and registers of the unit. The subsequent example shows the details of communication for serial readout of the actual display value.

This is the general format of a serial request string :

| EOT | AD1 | AD2 | C1 | C2 | ENQ |
|----------------------------------|-----|-----|----|----|-----|
| EOT = Control character (Hex 04) | | | | | |
| AD1 = Unit address, High Byte | | | | | |
| AD2 = Unit address, Low Byte | | | | | |
| C1 = Register code, High Byte | | | | | |
| C2 = Register code, Low Byte | | | | | |
| ENQ = Control character (Hex 05) | | | | | |

Example: Request for the actual display value from unit number 11:

| | | | | | | |
|---------------------|-----------|-----------|-----------|-----------|-----------|-----------|
| ASCII-Code: | EOT | 1 | 1 | : | 1 | ENQ |
| Hexadecimal: | 04 | 31 | 31 | 3A | 31 | 05 |
| Binary: | 0000 0100 | 0011 0001 | 0011 0001 | 0011 1010 | 0011 0001 | 0000 0101 |

Upon correct request the unit will respond as shown on the right. Leading zeros will be suppressed. BCC represents a block check character generated from an Exclusive-OR of all characters from C1 through ETX (inclusively)

| STX | C1 | C2 | x x x x x x x | ETX | BCC |
|----------------------------------|----|----|---------------|-----|-----|
| STX = Control character (Hex 02) | | | | | |
| C1 = Register code, High Byte | | | | | |
| C2 = Register code, Low Byte | | | | | |
| x x x x = Register data | | | | | |
| ETX = Control character (Hex 03) | | | | | |
| BCC = Block check character | | | | | |

With incorrect request strings, the unit only responds STX C1 C2 EOT or just NAK.

Provided the actual display value of the unit would be "-180" (example), the full response of the unit would be as shown below:

| | | | | | | | | | |
|---------------|--------------|--------------|--------------|--------------|--------------|--------------|--------------|--------------|--------------|
| ASCII | STX | : | 1 | - | 1 | 8 | 0 | ETX | BCC |
| Hex | 02 | 3A | 31 | 2D | 31 | 38 | 30 | 03 | 1C |
| Binary | 0000 0010 | 0011 1010 | 0011 0001 | 0010 1101 | 0011 0001 | 0011 1000 | 0011 0000 | 0000 0011 | 0001 1100 |

Again BCC represents the block check character formed from the Exclusive-OR of all characters from C1 through ETX

Units with serial link also allow setting or resetting the counter by serial command (similar to the external input or front key function). To activate the Reset command, please write "1" to register code "60". To release the Reset command again, write "0" to the same register.

The following strings show how to set or reset a unit with unit No. 11:

Reset ON :

| | | | | | | | | | |
|---------------|--------------|--------------|--------------|--------------|--------------|--------------|--------------|--------------|--------------|
| ASCII | EOT | AD1 | AD2 | STX | C1 | C2 | Data | ETX | BCC |
| Hex | 04 | 31 | 31 | 02 | 36 | 30 | 31 | 03 | 34 |
| Binary | 0000 0100 | 0011 0001 | 0011 0001 | 0000 0010 | 0011 0110 | 0011 0000 | 0011 0001 | 0000 0011 | 0011 0100 |

Reset OFF :

| | | | | | | | | | |
|---------------|--------------|--------------|--------------|--------------|--------------|--------------|--------------|--------------|--------------|
| ASCII | EOT | AD1 | AD2 | STX | C1 | C2 | Data | ETX | BCC |
| Hex | 04 | 31 | 31 | 02 | 36 | 30 | 30 | 03 | 35 |
| Binary | 0000 0100 | 0011 0001 | 0011 0001 | 0000 0010 | 0011 0110 | 0011 0000 | 0011 0000 | 0000 0011 | 0011 0101 |

For more details about serial communication please refer to the separate document "SERPRO"

4.5.2. Printer-Mode

The Printer Mode allows cyclic or manual activation of transmissions of the specified register data. The corresponding register can be specified by means of parameter „S-Code“.

Another parameter named „S-mod“ allows selection between two different string types:

| „S-mod“ | Transmission String Type | | | | | | | | | |
|----------|--------------------------|------|------|---|---|---|---|-----------------|-----------|-----------------|
| „Print1“ | Space | Sign | Data | | | | | | Line feed | Carriage return |
| | | +/- | X | X | X | X | X | X | LF | CR |
| „Print2“ | Sign | Data | | | | | | Carriage return | | |
| | +/- | X | X | X | X | X | X | CR | | |

The mode of activation of serial transmissions can be determined as follows:

| | |
|------------------------------------|---|
| Cyclic (timed) transmissions: | Set the Serial Timer to any value ≥ 0.010 sec. Select the desired string type by parameter " S-mod " After exit from the menu the timed transmissions will start automatically |
| Manual activation of transmissions | Set the Serial Timer to 0.000. Select the desired string type by parameter " S-mod " After exit from the menu a transmission can be activated at any time by shortly pressing the ENTER key |

5. Special Functions

5.1. Linearization

This function allows converting a non-linear input signal into a linear presentation or vice-versa. There are 16 interpolation points available, which can be freely arranged over the whole measuring range in any distance. Between two points the unit automatically will interpolate straight lines.

It is advisable to set many points into areas with strong bending, and to use only a few points in areas with little bending. „Linearisation Mode“ has to be set to either „1-quA“ or „4-quA“ to enable the linearization function (see subsequent drawing).

Parameters P01_x to P16_x select 16 x- coordinates, representing the display values which the unit would normally show in the display. With parameters P01_y to P16_y you can specify, which values you would like to display instead of the corresponding _x values.

This means e.g. that the unit will replace the previous P02_x value by the new P02_y value.



- With respect to the consistency of the linearization, the x- registers have to use continuously increasing values, e.g. the x- registers must conform to the constraint $P01_X < P02_X < \dots < P15_X < P16_X$.
- Independent of the selected linearization mode, the possible setting range of all registers P01_x, P01_y, ..., P16_x, P16_y is always -199999 ... 999999
- With measuring values lower than P01_x the display will always be P01_y
- With measuring values higher than P16_x, the display will always be P16_y.

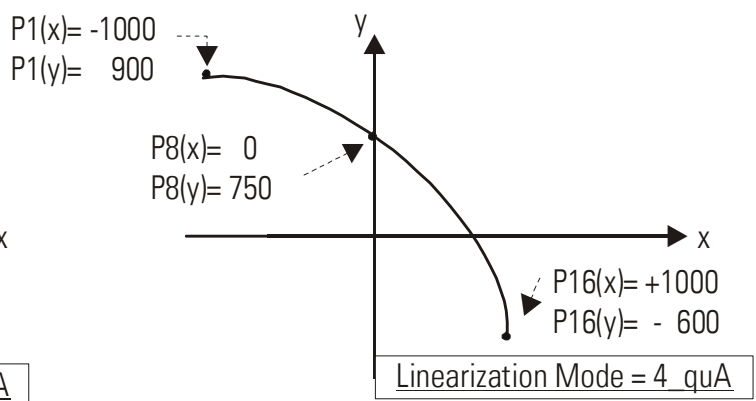
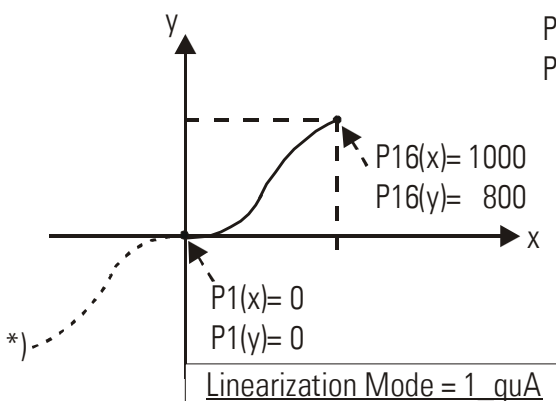

*.) Mirror of positive range

Application Example:

The picture below shows a Watergate where the opening is picked up by means of an incremental encoder. We would like to display the clearance of the gate "d", but the existing encoder information is proportional to the angular information ϕ .

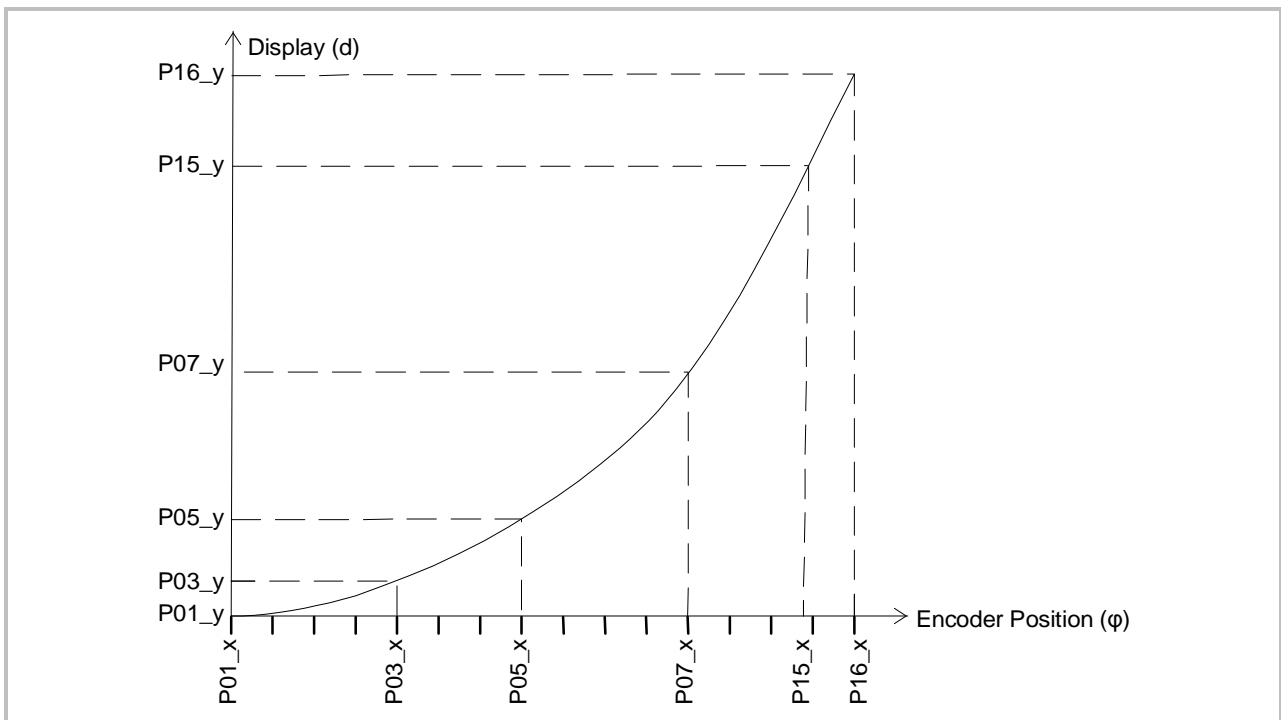
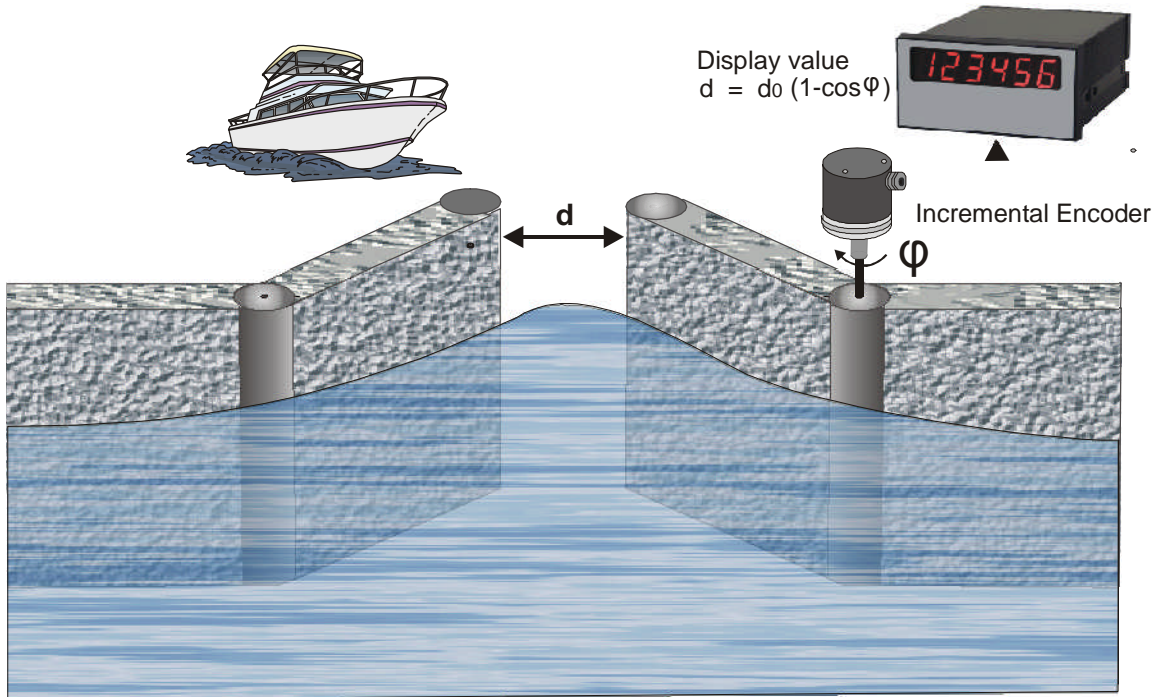

5.2. Manual Input or „Teaching“ of the Interpolation Points

Interpolation points to form the linearization curve can be entered one after each other, using the same procedure as for all other numeric parameters. This means you will have to enter all parameters P01_x to P16_x and P01_y to P16_y manually by keypad.



During manual input of interpolation points the unit will not examine the settings P01_x to P16_x. Therefore the operator is responsible for observation of the constraint $P01_X < P02_X < \dots < P15_X < P16_X$.

In most cases it should however be much more convenient to use the Teach function. For this method we have to move the encoder, step by step, from one interpolation point to the next. Every time we enter the desired display value by keypad.

How to use the Teach Function:

- Please select the desired range of linearization (see 4.1).
- Hold down the “Cmd” key for 3 seconds, until the display shows “tEACH”. Now the unit has switched over to the Teach mode. To start the teach procedure please press again “Cmd” within the next 10 seconds. The display will then show “P01_X”.
- With respect to the consistency required for linearization, all parameters from P01_X to P16_Y will first be overwritten by suitable initial values. Initial values for „P01_X” and „P01_Y” are -199999 and all other values will start with 999999.
- Press once more “Cmd” to display the actual encoder position. Then move the encoder to the first of the desired interpolation points
- When you read the x-value of your first interpolation point in the display, press “Cmd” again. This will automatically store the actual display value to the P01_x register. For about 1 second you will read “P01_y ” on the display, followed by the same reading again that has been stored previously
- This display value now can be edited like a regular parameter, and you can change it to the desired P01_y value
- When you read the desired P01_y value in your display, store it by pressing “Cmd” again. This will automatically cycle the display to the next interpolation point P02_x.

- Once we have reached and stored the last interpolation points P16_x/y, the routine will restart with P01_x again. You are free to double-check your settings once more or to make corrections.
- To conclude the Teach procedure, keep ENTER down for about 2 seconds. In the display you will read "StOP" for a short time, and then the unit returns to the normal operation. At the same time all linearization points have been finally stored.



- The unit will examine the constraint valid for the x-values of interpolation points. Every interpolation point must be higher than its preceding point. Where this constraint is breached, all 6 decimal points will blink automatically as a warning. Pressing the CMD key will not store the illegal value, but result in an error text "E.r.r.-.L.O."
- To exit the teach mode again, you have the following two possibilities:
 1. Press the enter key for 2 seconds. On the display you will read "StOP" for a short time, and then the unit will switch back to the normal mode.
 2. Just do nothing. After 10 seconds the unit will switch back to the normal mode automatically.

In both cases the parameters of linearization P01_X to P16_Y will not change.

6. Technical Appendix

6.1. Dimensions

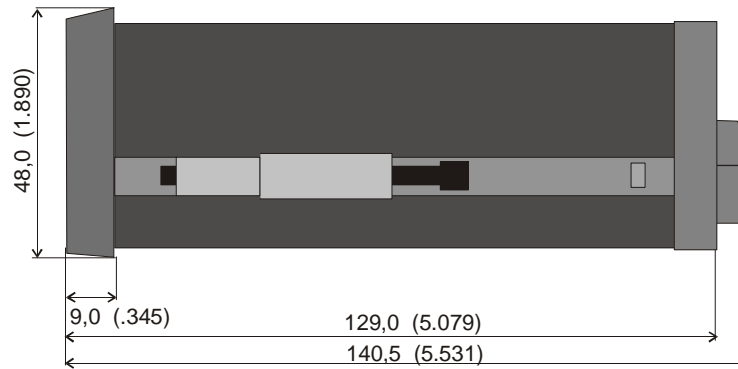
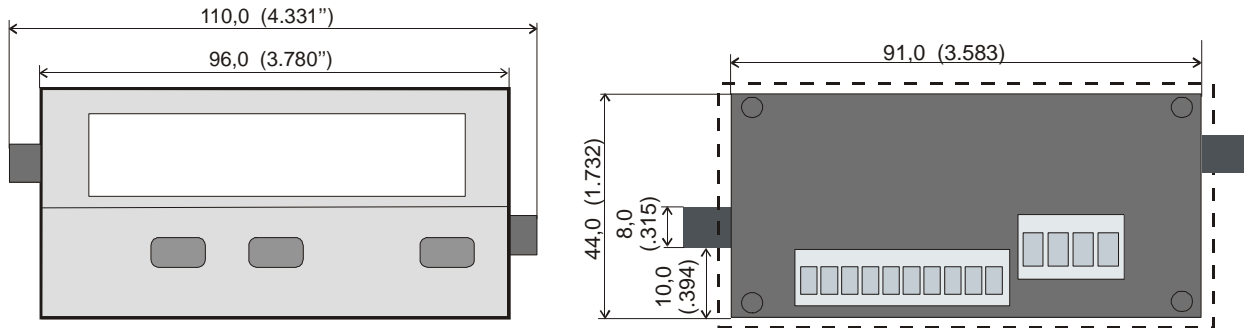

Panel cut out: 91 x 44 mm (3.583 x 1.732")

6.2. Technical Specifications

| | | |
|----------------------------------|---|--|
| Supply voltage AC | : | 115/230 V (+/- 12.5 %) |
| Consumption | : | 7.5 VA |
| Supply voltage DC | : | 24V (17 – 30V) |
| Consumption (without sensor) | : | 18 V = 120 mA, 24 V = 95 mA, 30 V = 80 mA (approx.) |
| Aux. voltage for encoder supply | : | 24V DC, +/- 15%, 120 mA (with AC + DC supply) (5 VDC / 120 mA with option TTLIN1) |
| AC Power | : | 7.5 VA |
| Inputs | : | 3 (PNP/NPN/Namur), A/B = Impulse, C = Reset |
| Input currents | : | 5.1 mA / 24 V (Ri = 4.7 kOhms) |
| Input level HTL (standard) | : | Low: 0 ... 3,5 V, High: 9 ... 30V |
| Input level TTL (option TTLIN1) | : | CMOS levels, Low: 0 ... 0.8 V, High: 3.6 ... 5.0 V |
| Max. input frequency | : | All counter modes: 100 kHz All other operating modes: 25 kHz Reset input C: 1 kHz (min. pulse duration 500 µsec) |
| Display update rate | : | approx. 7 msec (330 msec with tachometer operation) |
| Accuracy (frequency measurement) | : | +/- 1 ppm +/- 1 Digit |
| Analogue output (DX 346) | : | Current: 0/4...20 mA (load 0 – 270 ohms) Voltage: 0...+/- 10 V (max. 2 mA) |
| Resolution analogue | : | 14 Bits + Sign |
| Accuracy analogue | : | 0.1% |
| Analogue response time | : | see 4.3. |
| Ambient temperature | : | Operation: 0° - 45°C (32 – 113°F) Storage: -25° - +70°C (-13 – 158°F) |
| Housing | : | Norly UL94 – V-0 |
| Display | : | 6 Digit, LED, high- efficiency orange, 15 mm (0.59") |
| Protection class | : | Front IP65, Rear IP20 |
| Terminals | : | Signals max. 1.5 mm ² , AC power max. 2.5 mm ² |
| Switching outputs (DX 347) | : | PNP, max. 30 volts, max. 150 mA |
| Weight (net) approx. | : | 450 g |
| Conformity and Standards | : | EMC 2004/108/EC: EN 61000-6-2 EN 61000-6-3 LV 2006/95/EC: EN 61010-1 |

6.3. Parameter-List

6.3.1. General

| Description | Text | Min. Value | Max. Value | Default Value | Positions. | Characters | Serial Code |
|----------------------|--------|------------|------------|---------------|------------|------------|-------------|
| Unit Type | tYPE | 0 | 4 | 0 | 1 | 0 | 00 |
| Characteristic | CHAr | 0 | 1 | 1 | 1 | 0 | 01 |
| Brightness | briGht | 0 | 4 | 0 | 1 | 0 | 02 |
| Code | CodE | 0 | 2 | 0 | 1 | 0 | 03 |
| Frequency (Hz) | FrEqu | 1 | 25000 | 1000 | 5 | 0 | 04 |
| Display Value | diSPL | 1 | 99999 | 1000 | 5 | 0 | 05 |
| Decimal point | dPoint | 0 | 5 | 3 | 1 | 0 | 06 |
| Wait Time (sec) | L(Ait | 1 | 999 | 10 | 3 | 1 | 07 |
| Average Filter | FiLtEr | 0 | 4 | 0 | 1 | 0 | 08 |
| Display Format | diSFor | 0 | 3 | 0 | 1 | 0 | 09 |
| Frequency (Hz) | FrEqu | 1 | 25000 | 100 | 5 | 0 | 10 |
| Display Value | diSPL | 1 | 999999 | 100 | 6 | 0 | 11 |
| Wait Time (sec) | L(Ait | 1 | 999 | 50 | 3 | 1 | 12 |
| Average Filter | FiLtEr | 0 | 4 | 0 | 1 | 0 | 13 |
| Base | bASE | 0 | 6 | 0 | 1 | 0 | 14 |
| Start / Stop | StArt | 0 | 2 | 1 | 1 | 0 | 15 |
| Auto Reset | rESEt | 0 | 1 | 0 | 1 | 0 | 16 |
| Latch Function | LAtcH | 0 | 1 | 0 | 1 | 0 | 17 |
| Count Mode | n)odE | 0 | 5 | 3 | 1 | 0 | 18 |
| Factor | FActoR | 1 | 99999 | 10000 | 5 | 4 | 19 |
| Set Value | SEt | -199999 | 999999 | 0 | 86 | 0 | 20 |
| Reset / Set | rESEt | 0 | 3 | 3 | 1 | 0 | 21 |
| Decimal point | dPoint | 0 | 5 | 0 | 1 | 0 | 22 |
| Measuring Time (sec) | tin)E | 1 | 999999 | 1000 | 6 | 3 | 23 |
| Display Value | diSPL | 1 | 999999 | 1000 | 6 | 0 | 24 |
| Decimal point | dPoint | 0 | 5 | 0 | 1 | 0 | 25 |
| Wait Time (s) | L(Ait | 0 | 999 | 100 | 3 | 1 | 26 |

6.3.2. Linearization

| Description | Text | Min. Value | Max. Value | Default Value | Positions. | Characters | Serial Code |
|-------------|--------|------------|------------|---------------|------------|------------|-------------|
| L_Mode | LrnodE | 0 | 2 | 0 | 1 | 0 | D2 |
| P1(x) | P01_H | -199999 | 999999 | 999999 | 86 | 0 | A0 |
| P1(y) | P01_Y | -199999 | 999999 | 999999 | 86 | 0 | A1 |
| P2(x) | P02_H | -199999 | 999999 | 999999 | 86 | 0 | A2 |
| P2(y) | P02_Y | -199999 | 999999 | 999999 | 86 | 0 | A3 |
| P3(x) | P03_H | -199999 | 999999 | 999999 | 86 | 0 | A4 |
| P3(y) | P03_Y | -199999 | 999999 | 999999 | 86 | 0 | A5 |
| P4(x) | P04_H | -199999 | 999999 | 999999 | 86 | 0 | A6 |
| P4(y) | P04_Y | -199999 | 999999 | 999999 | 86 | 0 | A7 |
| P5(x) | P05_H | -199999 | 999999 | 999999 | 86 | 0 | A8 |
| P5(y) | P05_Y | -199999 | 999999 | 999999 | 86 | 0 | A9 |
| P6(x) | P06_H | -199999 | 999999 | 999999 | 86 | 0 | B0 |
| P6(y) | P06_Y | -199999 | 999999 | 999999 | 86 | 0 | B1 |
| P7(x) | P07_H | -199999 | 999999 | 999999 | 86 | 0 | B2 |
| P7(y) | P07_Y | -199999 | 999999 | 999999 | 86 | 0 | B3 |
| P8(x) | P08_H | -199999 | 999999 | 999999 | 86 | 0 | B4 |
| P8(y) | P08_Y | -199999 | 999999 | 999999 | 86 | 0 | B5 |
| P9(x) | P09_H | -199999 | 999999 | 999999 | 86 | 0 | B6 |
| P9(y) | P09_Y | -199999 | 999999 | 999999 | 86 | 0 | B7 |
| P10(x) | P10_H | -199999 | 999999 | 999999 | 86 | 0 | B8 |
| P10(y) | P10_Y | -199999 | 999999 | 999999 | 86 | 0 | B9 |
| P11(x) | P11_H | -199999 | 999999 | 999999 | 86 | 0 | C0 |
| P11(y) | P11_Y | -199999 | 999999 | 999999 | 86 | 0 | C1 |
| P12(x) | P12_H | -199999 | 999999 | 999999 | 86 | 0 | C2 |
| P12(y) | P12_Y | -199999 | 999999 | 999999 | 86 | 0 | C3 |
| P13(x) | P13_H | -199999 | 999999 | 999999 | 86 | 0 | C4 |
| P13(y) | P13_Y | -199999 | 999999 | 999999 | 86 | 0 | C5 |
| P14(x) | P14_H | -199999 | 999999 | 999999 | 86 | 0 | C6 |
| P14(y) | P14_Y | -199999 | 999999 | 999999 | 86 | 0 | C7 |
| P15(x) | P15_H | -199999 | 999999 | 999999 | 86 | 0 | C8 |
| P15(y) | P15_Y | -199999 | 999999 | 999999 | 86 | 0 | C9 |
| P16(x) | P16_H | -199999 | 999999 | 999999 | 86 | 0 | D0 |
| P16(y) | P16_Y | -199999 | 999999 | 999999 | 86 | 0 | D1 |

6.3.3. Analogue Output (DX 346)

| Description | Text | Min. Value | Max. Value | Default Value | Positions. | Characters | Serial Code |
|----------------|--------|------------|------------|---------------|------------|------------|-------------|
| Analogue Start | An-bEG | -199999 | 999999 | 0 | 86 | 0 | 31 |
| Analogue End | An-End | -199999 | 999999 | 10000 | 86 | 0 | 32 |
| Analogue Mode | A-CHAr | 0 | 3 | 1 | 1 | 0 | 33 |
| Offset | OFFSEt | -9999 | 9999 | 0 | 84 | 3 | 34 |
| Gain | GAin | 0 | 9999 | 1000 | 4 | 2 | 35 |

6.3.4. Preselections (DX 347)

| Description | Text | Min. Value | Max. Value | Default Value | Positions. | Characters | Serial Code |
|----------------------|-------|------------|------------|---------------|------------|------------|-------------|
| Preselection Value 1 | PrES1 | -199999 | 999999 | 10000 | 86 | 0 | 27 |
| Preselection Value 2 | PrES2 | -199999 | 999999 | 5000 | 86 | 0 | 28 |
| Preselection Mode 1 | CHAr1 | 0 | 5 | 0 | 1 | 0 | 29 |
| Preselection Mode 2 | CHAr2 | 0 | 5 | 0 | 1 | 0 | 30 |
| Hysteresis 1 | HYSt1 | 0 | 99999 | 0 | 5 | 0 | 31 |
| Hysteresis 2 | HYSt2 | 0 | 99999 | 0 | 5 | 0 | 32 |

6.3.5. Serial interface (DX 348)

| Description | Text | Min. Value | Max. Value | Default Value | Positions. | Characters | Serial Code |
|------------------|--------|------------|------------|---------------|------------|------------|-------------|
| Serial Timer (s) | S-tin) | 0 | 9999 | 100 | 4 | 3 | 38 |
| Serial Mode | S-n)od | 0 | 2 | 0 | 1 | 0 | 39 |
| Serial Code | S-CodE | 100 | 120 | 101 | 3 | 0 | 40 |
| Serial Unit Nr | S-Unit | 0 | 99 | 11 | 2 | 0 | 90 |
| Serial Format | S-Forn | 0 | 9 | 0 | 1 | 0 | 92 |
| Serial Baudrate | S-bAUd | 0 | 6 | 0 | 1 | 0 | 91 |

6.4. Commissioning Form

| | | | |
|------------------------|-------------------------------------|---------------------------------------|---------------------------------------|
| Date: | | Software: | |
| Operator: | | Serial number: | |
| Basic settings: | Unit Type: | NPN /PNP: | |
| | Brightness: | Code: | |
| | Linearization Mode(*): | | |
| | Additional DX346 | Analogue Mode: Gain | Offset |
| | Additional DX347 | Preselection Mode 1: Hysteresis 1: | Preselection Mode 2: Hysteresis 2: |
| Additional DX348 | Serial Unit Number: Serial Baud: | Serial Format: | |

(*) Appears only with modes "RPM" and "Count"

| | | | |
|------------------------------|-----------------|------------------|--|
| Operation Mode (Type) | | | |
| RPM | Frequency (Hz): | Display Value: | |
| | Decimal Point: | Wait Time(sec): | |
| | Average Filter: | | |
| Time | Display Format: | Frequency (Hz): | |
| | Display Value: | Wait Time (sec): | |
| | Average Filter: | | |
| Timer | Base: | Start/Stop: | |
| | Auto Reset: | Latch Function: | |
| Count | Count Mode: | Factor: | |
| | Set Value: | Reset/Set: | |
| | Decimal Point: | | |
| Speed | Time (sec): | Display Value: | |
| | Decimal Point: | Wait Time (sec): | |

| | | | |
|-------------------------------|-------------------------------------|-----------------|--|
| Additional parameters: | | | |
| Additional DX346 | Analogue Begin: | Analogue End: | |
| Additional DX347 | Preselection 1: | Preselection 2: | |
| Additional DX348 | Serial Timer (sec): Serial Code: | Serial Mode: | |

| <u>Linearization</u> (*) | | | |
|--------------------------|--------|---------|---------|
| P1(x): | P1(y): | P9(x): | P9(y): |
| P2(x): | P2(y): | P10(x): | P10(y): |
| P3(x): | P3(y): | P11(x): | P11(y): |
| P4(x): | P4(y): | P12(x): | P12(y): |
| P5(x): | P5(y): | P13(x): | P13(y): |
| P6(x): | P6(y): | P14(x): | P14(y): |
| P7(x): | P7(y): | P15(x): | P15(y): |
| P8(x): | P8(y): | P16(x): | P16(y): |

(*) Appears only with Modes "RPM" and "Count" if Linearization has been enabled

