



PS340 and PS641

Single Axis Position Controllers for Low-Cost Solutions

Product features:

- Autonomous precision controller for any kind of positioning applications
- Easy parameter setting and immediately ready to work with minimum commissioning time
- High accuracy due to high feedback frequency range (300 kHz with TTL encoders and 200 kHz with HTL encoders)
- Extremely smooth motion by optimized S-shape profiles
- High dynamic response by means of short cycle time
- Various modes of operation for absolute and relative positions (incremental length), loop operation and positioning on index signals or print marks
- Most compact unit including operator panel for direct access and RS232 interface for remote access
- PROFIBUS DP interface available (option)

Available models:

- **PS340**: for more details please refer to chapter [2](#)
- **PS641**: for more details please refer to chapter [2](#)

| Version: | Description: |
|--------------------------|---|
| PS34001a/June 14/TJ/NW | First edition |
| Ps34001b_oi/May 15/TJ/AG | 1. Analog output -20 ...+20 mA (instead of 0 ... 20 mA). 2. Different spelling corrections. 3. Design, "Safety Instructions" and "Technical Specifications" updated. 4. "Legal notices" supplemented. |

| Legal notices: |
|--|
| All contents included in this manual are protected by the terms of use and copyrights of motrona GmbH. Any reproduction, modification, usage or publication in other electronic and printed media as well as in the internet requires prior written authorization by motrona GmbH. |

Table of Contents

| | | |
|----------|--|-----------|
| 1 | Safety Instructions and Responsibility | 4 |
| 1.1 | General Safety Instructions..... | 4 |
| 1.2 | Use according to the intended purpose | 4 |
| 1.3 | Installation..... | 5 |
| 1.4 | Cleaning, Maintenance and Service Notes..... | 5 |
| 2 | Available Models..... | 6 |
| 3 | Introduction | 7 |
| 4 | Electrical Connections | 8 |
| 4.1 | Power Supply..... | 10 |
| 4.2 | Auxiliary Outputs for Encoder Supply..... | 10 |
| 4.3 | Impulse Inputs for Incremental Encoders..... | 10 |
| 4.4 | Control Inputs Cont.1 – Cont.4..... | 11 |
| 4.5 | Switching Outputs K1 – K4 | 11 |
| 4.6 | Serial Interface | 11 |
| 4.7 | Analog Outputs..... | 11 |
| 5 | Functional description..... | 12 |
| 5.1 | Principle of operation | 12 |
| 5.2 | System Configuration..... | 12 |
| 6 | Keypad Operation | 13 |
| 6.1 | Normal Operation..... | 13 |
| 6.2 | General Setup Procedure | 13 |
| 6.3 | Direct Fast Access to Incremental Length Setting..... | 14 |
| 6.4 | Change of Parameter Values on the Numeric Level | 15 |
| 6.5 | Code Protection against Unauthorized Keypad Access | 16 |
| 6.6 | Return from the Programming Levels and Time-Out Function | 16 |
| 6.7 | Reset all Parameters to Factory Default Values | 16 |

| | | |
|-----------|---|-----------|
| 7 | Menu Structure and Description of Parameters | 17 |
| 7.1 | Summary of the Menu..... | 17 |
| 7.2 | Description of the Parameters | 19 |
| 8 | Description of Commands and Outputs | 30 |
| 8.1 | Commands..... | 30 |
| 8.2 | Outputs | 32 |
| 8.3 | Display of Actual Values | 33 |
| 8.4 | Error Messages | 34 |
| 9 | Steps for Commissioning | 35 |
| 9.1 | Use of the adjust menu | 36 |
| 9.2 | Set Directions of Rotation | 37 |
| 9.3 | Set Directions of Rotation without PC | 37 |
| 9.4 | Setting of the Proportional Gain | 37 |
| 9.5 | Optimization of the controller | 38 |
| 10 | Appendix for model PS641 | 39 |
| 10.1 | Relay Outputs | 39 |
| 10.2 | Front Thumbwheel Switches..... | 39 |
| 11 | Technical Specifications | 40 |
| 12 | Dimensions..... | 42 |
| 12.1 | Model PS340: | 42 |
| 12.2 | Model PS641: | 43 |

1 Safety Instructions and Responsibility

1.1 General Safety Instructions

This operation manual is a significant component of the unit and includes important rules and hints about the installation, function and usage. Non-observance can result in damage and/or impairment of the functions to the unit or the machine or even in injury to persons using the equipment!

Please read the following instructions carefully before operating the device and observe all safety and warning instructions! Keep the manual for later use.

A pertinent qualification of the respective staff is a fundamental requirement in order to use these manual. The unit must be installed, connected and put into operation by a qualified electrician.

Liability exclusion: The manufacturer is not liable for personal injury and/or damage to property and for consequential damage, due to incorrect handling, installation and operation. Further claims, due to errors in the operation manual as well as misinterpretations are excluded from liability.

In addition the manufacturer reserve the right to modify the hardware, software or operation manual at any time and without prior notice. Therefore, there might be minor differences between the unit and the descriptions in operation manual.

The raiser respectively positioner is exclusively responsible for the safety of the system and equipment where the unit will be integrated.

During installation or maintenance all general and also all country- and application-specific safety rules and standards must be observed.

If the device is used in processes, where a failure or faulty operation could damage the system or injure persons, appropriate precautions to avoid such consequences must be taken.

1.2 Use according to the intended purpose

The unit is intended exclusively for use in industrial machines, constructions and systems. Non-conforming usage does not correspond to the provisions and lies within the sole responsibility of the user. The manufacturer is not liable for damages which has arisen through unsuitable and improper use.

Please note that device may only be installed in proper form and used in a technically perfect condition (in accordance to the "Technical Specifications", see chapter [11](#)). The device is not suitable for operation in explosion-proof areas or areas which are excluded by the EN 61010-1 standard.

1.3 Installation

The device is only allowed to be installed and operated within the permissible temperature range. Please ensure an adequate ventilation and avoid all direct contact between the device and hot or aggressive gases and liquids.

Before installation or maintenance, the unit must be disconnected from all voltage-sources. Further it must be ensured that no danger can arise by touching the disconnected voltage-sources.

Devices which are supplied by AC-voltages, must be connected exclusively by switches, respectively circuit-breakers with the low voltage network. The switch or circuit-breaker must be placed as near as possible to the device and further indicated as separator.

Incoming as well as outgoing wires and wires for extra low voltages (ELV) must be separated from dangerous electrical cables (SELV circuits) by using a double resp. increased isolation.

All selected wires and isolations must be conform to the provided voltage- and temperature-ranges. Further all country- and application-specific standards, which are relevant for structure, form and quality of the wires, must be ensured. Indications about the permissible wire cross-sections for wiring are described in the "Technical Specifications" (see chapter [11](#)).

Before first start-up it must be ensured that all connections and wires are firmly seated and secured in the screw terminals. All (inclusively unused) terminals must be fastened by turning the relevant screws clockwise up to the stop.

Overvoltages at the connections must be limited to values in accordance to the overvoltage category II.

For placement, wiring, environmental conditions as well as shielding and earthing/grounding of the supply lines the general standards of industrial automation industry and the specific shielding instructions of the manufacturer are valid. Please find all respective hints and rules on www.motrona.com/download.html --> "[General EMC Rules for Wiring, Screening and Earthing]".



1.4 Cleaning, Maintenance and Service Notes

To clean the front of the unit please use only a slightly damp (not wet!), soft cloth. For the rear no cleaning is necessary. For an unscheduled, individual cleaning of the rear the maintenance staff or assembler is self-responsible.

During normal operation no maintenance is necessary. In case of unexpected problems, failures or malfunctions the device must be shipped for back to the manufacturer for checking, adjustment and reparation (if necessary). Unauthorized opening and repairing can have negative effects or failures to the protection-measures of the unit.

2 Available Models

The two models as shown below are available. Both models are fully similar in terms of function and performance; however there is some difference with the size, the alert outputs and the length setting.

| | |
|---|---|
|  The PS340 device features a red LED display showing the number '123456'. Below the display is a keypad with four buttons: a 'P' button, a right arrow, a left arrow, and a return key. To the right of the keypad is a vertical status indicator with five green LEDs. | <p>PS340:</p> <ul style="list-style-type: none">▪ Front size 96 x 48 mm (3.780" x 1.890")▪ Incremental length setting by keypad▪ Analog output 14 bits▪ 4 power transistor outputs (alert) |
|  The PS641 device features a red LED display showing the number '123456'. Below the display is a keypad with four buttons: a 'P' button, a right arrow, a left arrow, and a return key. Below the keypad is a row of six thumbwheel switches. To the right of the keypad is a vertical status indicator with five green LEDs. | <p>PS641:</p> <ul style="list-style-type: none">▪ Front size 96 x 96 mm (3.780" x 3.780")▪ Incremental length setting by keypad or by front thumbwheel switches▪ Analog output 14 bits▪ 4 power transistor alert outputs▪ 4 additional relay alert outputs |

Both models are suitable for front panel or operator desk mounting, by means of the included mounting clamps.

Where you desire to mount the units on DIN rails inside a cabinet, please refer to the mounting brackets type SM 300 and SM 600 available as accessories.

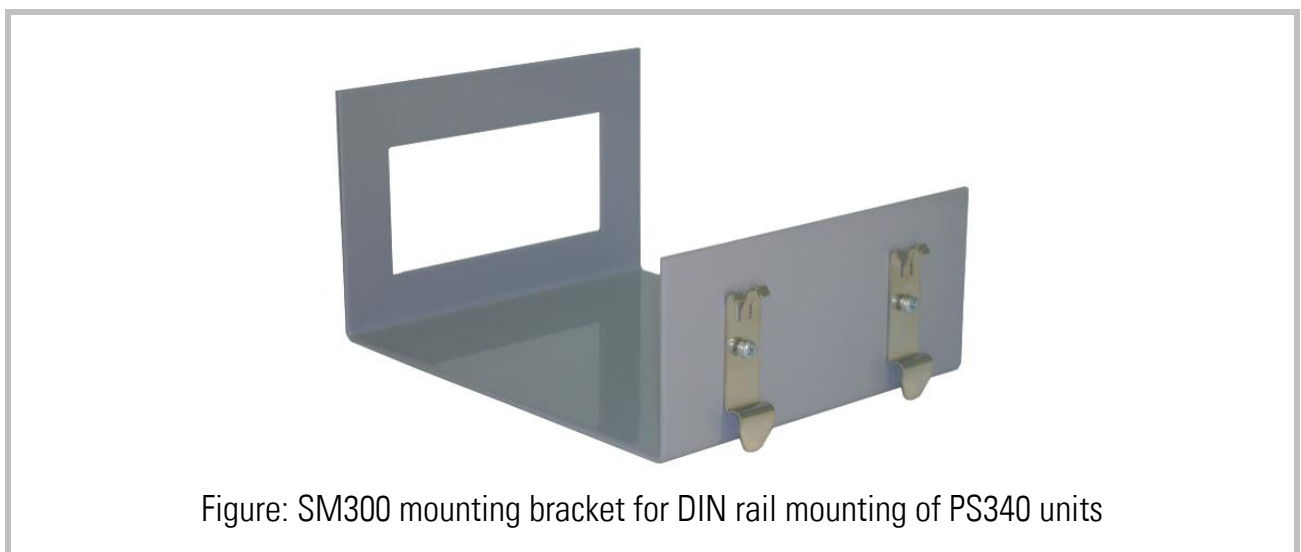

Figure: SM300 mounting bracket for DIN rail mounting of PS340 units

3 Introduction

The PS340/PS641 units have been designed for the special requirements of single-axis positioning systems, under consideration of maximum performance and accuracy, with minimum stress for all mechanical parts. Very short control cycles together with intelligent motion profiles provide excellent performance under all operating conditions.

This unit is very easy to set up. All settings can be made either by keypad and display at the unit or by PC, with use of the motrona operator software OS 6.0.

All relevant operational parameters and variables are accessible by RS232/RS485 interface. For PROFIBUS applications, our PB251 gateway is available. Therefore the user has multiple possibilities for remote control of all parameters via operator terminals, PC or PLC systems



- This manual first provides all basic instructions for operation of model PS340
- For operation of relays and thumbwheels with model PS641 see appendix
- For PC setup our "OS 6.0" software is available on the CD included to delivery, or on our homepage www.motrona.com
- For communication by PLC or IPC or by a remote operator terminal, please observe the serial protocol details described in our separate manual "Serpro".
- PROFIBUS communication is possible with use of our gateway PB251.

4 Electrical Connections

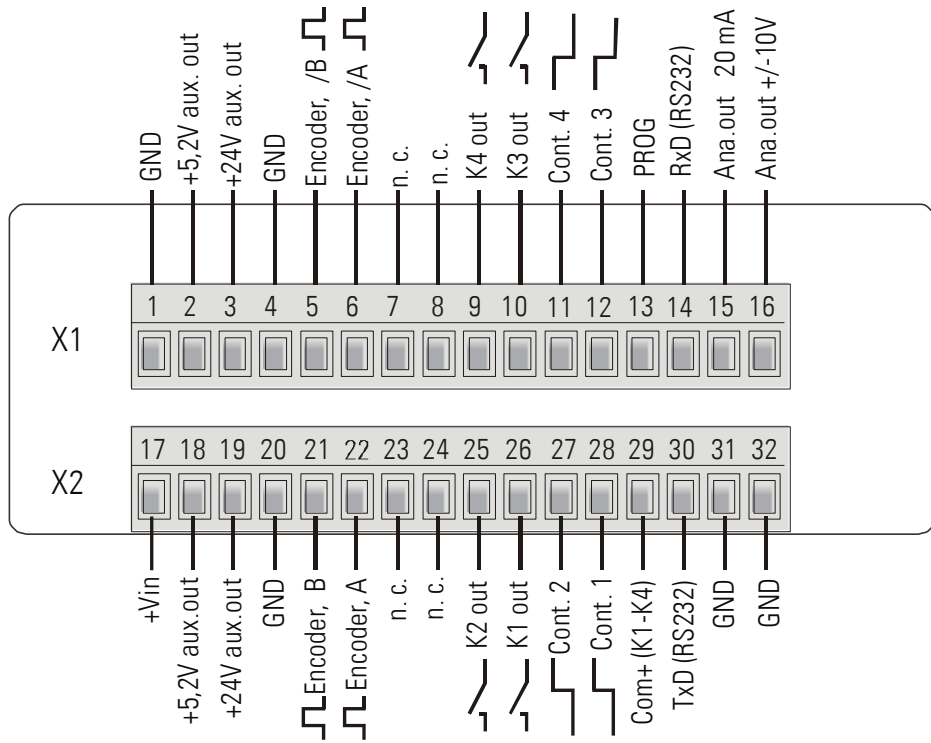

Example shows wiring for encoders with 5 V power supply and RS422 line driver output

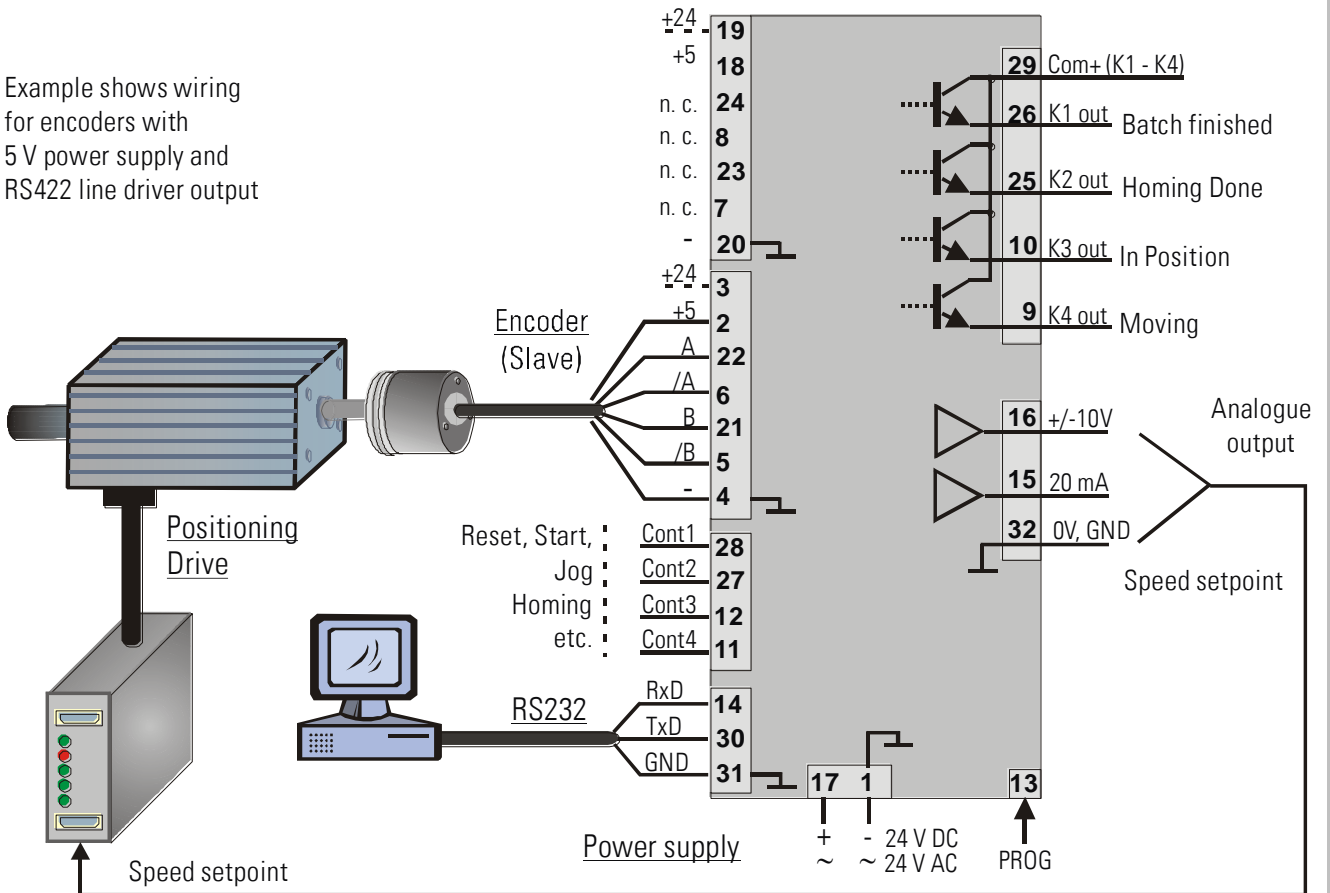

| Terminal | Name | Function |
|----------|-----------------|---|
| 01 | GND | Common Ground Potential (0V) |
| 02 | +5.2 V out | Aux. output 5.2 V/150 mA for encoder supply *) |
| 03 | +24 V out | Aux. output 24 V/120 mA for encoder supply *) |
| 04 | GND | Common Ground Potential (0V) |
| 05 | Encoder, /B | Encoder of the positioning drive, channel /B (B inverted) |
| 06 | Encoder, /A | Encoder of the positioning drive, channel /A (A inverted) |
| 07 | n. c. | n. c. |
| 08 | n. c. | n. c. |
| 09 | K4 out | Digital output K4, transistor PNP 30 V, 350 mA |
| 10 | K3 out | Digital output K3, transistor PNP 30 V, 350 mA |
| 11 | Cont. 4 | Programmable control input |
| 12 | Cont. 3 | Programmable control input |
| 13 | (PROG) | (for download of new firmware only, not for general use) |
| 14 | RxD | Serial RS232 interface, input (Receive Data) |
| 15 | Ana. out 20 mA | Analog output -20 mA ... +20 mA (Slave speed reference) **) |
| 16 | Ana. out +/-10V | Analog output -10 V ... +10 V (Slave speed reference) **) |
| 17 | +Vin | Power supply input, +17 ... 40 VDC or 24 VAC |
| 18 | +5.2 V out | Aux. output 5.2 V/150 mA for encoder supply |
| 19 | +24 V out | Aux. output 24 V/120 mA for encoder supply |
| 20 | GND | Common Ground Potential (0 V) |
| 21 | Encoder, B | Encoder of the positioning drive, channel B (non-inverted) |
| 22 | Encoder, A | Encoder of the positioning drive, channel A (non-inverted) |
| 23 | n. c. | n. c. |
| 24 | n. c. | n. c. |
| 25 | K2 out | Digital output K2, transistor PNP 30 V, 350 mA |
| 26 | K1 out | Digital output K1, transistor PNP 30 V, 350 mA |
| 27 | Cont. 2 | Programmable control input |
| 28 | Cont. 1 | Programmable control input |
| 29 | Com+ (K1 to K4) | Common positive input for transistor outputs K1 to K4 |
| 30 | TxD | Serial RS232 interface, output (Transmit Data) |
| 31 | GND | Common Ground Potential (0 V) |
| 32 | GND | Common Ground Potential (0 V) for DC or AC power supply |

*) 120 mA and 150 mA are per output, i.e. total maximum currents are 240 mA and 300 mA

**) In general, the voltage output terminal 16 should be used for the slave speed signal

4.1 Power Supply

The PS340 controller accepts both, a 17 to 40 VDC power or a 24 VAC power for supply via terminals 17 and 1. The current consumption depends on the level of the input voltage and some internal conditions; therefore it can vary in a range from 100 to 200 mA (auxiliary currents taken from the unit for encoder supply not included).

4.2 Auxiliary Outputs for Encoder Supply

Terminals 2 and 18 provide an auxiliary output with approx. +5.2 VDC (300 mA totally).
Terminals 3 and 19 provide an auxiliary output with approx. +24 VDC (240 mA totally)

4.3 Pulse Input for Incremental Encoders

All input characteristics of the pulse input can be set by the parameter menu. The unit works with quadrature information (A/B, 90°) only. In theory, any of the following encoder characteristics would be applicable:

- Symmetric differential signals according to RS422 standard, however 1V min. as differential voltage.
- TTL input at a level of 3.0 to 5 V (differential, with inverted signal)
- TTL input at a level of 3.0 to 5 V (single-ended) *)
- HTL signals at a 10 ... 30 V level
(alternatively differential A, /A, B, /B, or single-ended A, B only)
- Impulses from photocells or proximity switches etc. providing a HTL level (10 ... 30 V)
- Proximity switches according to NAMUR (2-wire) standard
(may need additional remote resistor)

*) requires special settings of the threshold parameters, see "Special parameters F08"



- For trouble-free operation it is mandatory to use a quadrature encoder with channels A and B or with channels A, /A, and B, /B (90° phase displacement).
- Where the pulse level is HTL (10 to 30 V) you can use either single-ended signals (A and B only) or differential signals (A, /A, B, /B)
- Where the pulse level is TTL or RS422, it is strictly recommended to use symmetric differential signals (with inverted channels /A and /B).
Under industrial environment conditions, single-ended TTL signals may cause serious problems due to insufficient EMC immunity of the signal lines
- All encoder input lines are internally terminated by pull-down resistors (8.5 kOhm). Where encoders with pure NPN outputs are used, corresponding pull-up resistors must be available inside the encoder or externally to ensure proper function (1 kOhm to 3.3 kOhm).

4.4 Control Inputs Cont.1 – Cont.4

These inputs can be configured for remote functions like Reset, Start, Jog, Homing etc. All control inputs require HTL level. They can be individually set to either NPN (switch to -) or PNP (switch to +) characteristics. For applications where edge-triggered action is needed, the menu allows to set the active edge (rising or falling). The Control inputs will also accept signals with Namur (2-wire) standard.



For reliable operation of the Control Inputs a minimum pulse duration of 50 μ s must be ensured. Especially when using the Z marker pulse of a HTL encoder for index tracking, please verify that this minimum duration can be kept even with maximum speed of the machine

4.5 Switching Outputs K1 – K4

PS340 provides four digital outputs to signal control states like Moving, In Position, Homing Done or Batch Finished. K1 to K4 are fast-switching and short-circuit-proof transistor outputs with a switching capability of 5 to 30 V/350 mA each. The switching voltage of the outputs must be applied remotely to the Com+ input (terminal 29)

4.6 Serial Interface

The serial RS232 interface can be used for the following purposes:

- Set-up of the unit by PC with use of the OS32 PC software
- Remote change of parameters during operation
- Remote readout of actual values by PLC or PC

The figure below explains the connection between the PS340 unit and a PC using the standard Sub-D-9 serial connector

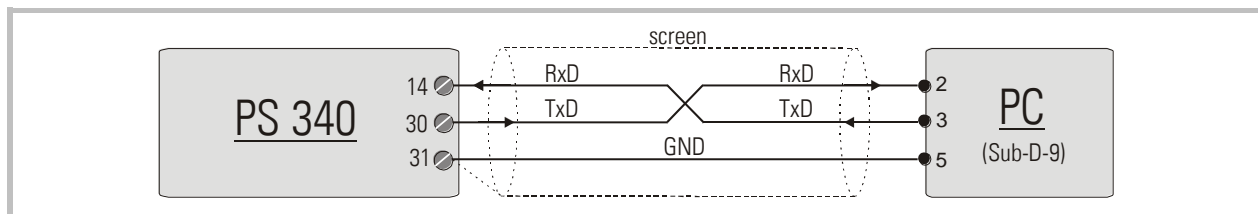

For details of the serial communication protocol, please refer to the special “Serpro” manual.

4.7 Analog Outputs

The unit provides a voltage output of ± 10 V (load = 3 mA), and a current output of ± 20 mA (load = 0 to 270 Ohms), both at a resolution of 14 bits (13 bits + sign).

With most standard applications the voltage output is used as speed set-point signal, connected to the speed input of the positioning drive.



Important note: “Voltage out” and “Current out” cannot be used together. Please do never connect mA and V simultaneously!

5 Functional description

5.1 Principle of operation

The drive can move to any relative or absolute position depending on the operating mode (see section [7.2.2](#) / parameter F02.002 "Operation Mode") and therefore cover a great variety of positioning applications:

- Incremental Length:** Moving of a certain length from the actual position.
This mode can be used for discontinuous cutting of material in start-stop mode, i.e. move the material for a certain length and cut during standstill.
- Relative Positioning:** Moving of a certain length related to the last target position.
- Absolute Positioning:** Moving to a preset absolute position.
After switch-on of the machine the drive can move to a defined starting position with a homing cycle and thereby set a defined reference point for the absolute positions.
- Loop Operation:** Moving consecutively to several absolute positions in endless loop operation
- Incremental Operation with print mark control:** Relative positioning to a position specified by an index mark.
This mode can be used for discontinuous cutting of pre-printed material in start-stop mode, i.e. move the material for a certain length and cut during the standstill on a position determined by a print mark.

5.2 System Configuration

The encoder resolution should be at least 5 times higher than the maximum acceptable position error.

At maximum positioning speed the input frequency must not exceed the maximum level of 300 kHz (RS422 and TTL differential encoder) or 200 KHz (HTL and TTL single-ended encoders).

It is necessary to adjust the positioning drive to its maximum dynamic response (no internal ramps, no integral control loop, high proportional gain), because the PS340 and PS641 will generate the ramps which the drive has to follow with no additional delay







For safety reasons it is mandatory to limit the traveling range of the positioning drive by independent limit switches at both ends, in order to avoid damage by overshoot upon failure of the electronic control system!

6 Keypad Operation

An overview of all parameters and explanations can be found under section 7.

The menu of the unit uses four keys, hereinafter named as follows:

| | | | |
|---|---|--|---|
|  |  |  |  |
| PROG | UP | DOWN | ENTER |

Key functions depend on the actual operating state of the unit. Essentially we have to describe three basic states:

- Normal operation
- General setup procedure
- Direct fast access to scaling factors

6.1 Normal Operation

In this mode the unit operates to the settings defined upon setup. All front keys may have customer-defined functions according to the specifications met in the keypad definition menu F06 (e.g. Display scroll, Jog, Homing or else)

6.2 General Setup Procedure









The unit changes over from normal operation to setup level when keeping the  key down for at least 2 seconds. Thereafter you can select one of the parameter groups F01 to F09.



**Setup operation is disabled while the drive is within a positioning cycle.
I. e. the setup procedure cannot be started before the actual positioning cycle has been finished and the drive has reached the target position.**

Inside the group you can now select the desired parameter and set the value according to need. After this you can either set more parameters or return to the normal operation.

The adjoining sequence of key operations explains how to change **Parameter number 052 of group F06 from the original value of 0 to a new value of 8.**

| Step | State | Key action | | Display | Comment |
|------|-----------------------------|---|----------|------------------------|--|
| 00 | Normal operation | | | Actual Error | |
| 01 | |  | > 2 sec. | F01 | Display of the Parameter group |
| 02 | Level: Parameter group |  | 5 x | F02 ... F06 | Select group # F06 |
| 03 | |  | | F06.050 | Confirmation of F06. The first parameter of this group is F06.050 |
| 04 | Level: Parameter numbers |  | 2 x | F06.051 ... F06.052 | Select parameter 052 |
| 05 | |  | | 0 | Parameter 052 appears in display, actual setting is 0 |
| 06 | Level: Parameter values |  | 8 x | 1 8 | Setting has been modified from 0 to 8 |
| 07 | |  | | F06.052 | Save the new setting (8) |
| 08 | Level: Parameter numbers |  | | F06 | Return to level parameter groups |
| 09 | Level: Parameter groups |  | | Actual Error | Return to normal operation |
| 10 | Normal operation | | | | |



During the general setup procedure all control activities remain disabled. New parameter settings become active after return to normal operation only.

6.3 Direct Fast Access to Incremental Length Setting

To get to the fast access routine, please press both



and



at the same time

This will access the parameter group F01 right away. To change the settings follow the same procedure as already described above.





Besides the advantage of direct access, the fundamental difference to general setup is the following:



- Direct fast access is enabled when the drive is within a positioning cycle.
- During the fast access procedure all control functions remain fully active.
- Access is limited to incremental length and position number setting; no other parameters can be changed.

6.4 Change of Parameter Values on the Numeric Level











The numeric range of the parameters is up to 6 digits. Some of the parameters may also include a sign. For fast and easy setting of these values the menu uses an algorithm as shown subsequently. During this operation the front keys have the following functions:

|  |  |  |  |
|--|---|---|---|
| PROG | UP | DOWN | ENTER |
| Saves the actual value shown in the display and returns to the parameter selection level | Increments the highlighted (blinking) digit | Decrements the highlighted (blinking) digit | Shifts the cursor (blinking digit) one position to the left, or from utmost left to right |

With signed parameters the left digit scrolls from **0 to 9** and then shows “-”, (negative) and “-1” (minus one). The example below shows how to change a parameter from the actual setting of 1024 to the new setting of 250 000.

This example assumes that you have already selected the parameter group and the parameter number, and that you actually read the parameter value in the display.

Highlighted digits appear on colored background.

| Step | Display | Key action | Comment |
|------|---------|---|--|
| 00 | 001024 | | Display of actual parameter setting, last digit is highlighted |
| 01 | |  4 x | Scroll last digit down to 0 |
| 02 | 001020 |  | Shift cursor to left |
| 03 | 001020 |  2 x | Scroll highlighted digit down to 0 |
| 04 | 001000 |  2 x | Shift cursor 2 positions left |
| 05 | 001000 |  | Scroll highlighted digit down to 0 |
| 06 | 000000 |  | Shift cursor left |
| 07 | 000000 |  5 x | Scroll highlighted digit up to 5 |
| 08 | 050000 |  | Shift cursor left |
| 09 | 050000 |  2 x | Scroll highlighted digit up to 2 |
| 10 | 250000 |  | Save new setting and return to the parameter number level |

6.5 Code Protection against Unauthorized Keypad Access

Parameter group F09 allows to define an own locking code for each of the parameter menus. This permits to limit access to certain parameter groups to specific persons only.

When accessing a protected parameter group, the display will first show "CODE" and wait for your entry. To continue keypad operations you must now enter the code which you have stored before, otherwise the unit will return to normal operation again.

After entering your code, press the ENTER key and keep it down until the unit responds. When your code was correct, the response will be "YES" and the menu will work normally. With incorrect code the response will be "NO" and the menu remains locked.

6.6 Return from the Programming Levels and Time-Out Function



At any time the PROG key sets the menu one level up and finally returns to normal operation. The same step occurs automatically via the time-out function, when during a period of 10 seconds no key has been touched.

Termination of the menu by automatic time-out will not store new settings, unless they have already been stored by the PROG key after editing.

6.7 Reset all Parameters to Factory Default Values

Upon special need it may be desirable to set all parameters back to their original factory settings (e.g. because you have forgotten your access code, or by too many change of settings you have achieved a complex parameter state). Default values are indicated in the parameter tables shown later.

To reset the unit to default, please take the following steps:

- Switch power off
- Press  and  simultaneously
- Switch power on while you keep pressing both keys



Where you decide to take this action, please note that all parameters and settings will be lost, and that you will need to run a new setup procedure again.

7 Menu Structure and Description of Parameters

All parameters are arranged in a reasonable order of functional groups (F01 to F09)
 You must only set those parameters which are really relevant for your specific application.
 Unused parameters can remain as they actually are.

7.1 Summary of the Menu

This section shows a summary of the parameter groups, with an assignment to the functional parts of the unit.

| Group | Function | Group | Function |
|------------|----------------------------|------------|---|
| F01 | Position Setting | F03 | Definitions for the Master Encoder |
| 000 | Incremental Length | 026 | Not applicable |
| 001 | Position Number | 027 | Not applicable |
| F02 | Operational Setting | 028 | Not applicable |
| 002 | Operation Mode | 029 | Reserved |
| 003 | Acceleration Ramp | 030 | Reserved |
| 004 | Deceleration Ramp | 031 | Reserved |
| 005 | Emergency Stop Ramp | F04 | Definitions for the Slave Encoder |
| 006 | Pulses per 1000 LU | 032 | Encoder Properties |
| 007 | Position Window | 033 | Edge Counting |
| 008 | Frequency Max. Speed | 034 | Counting Direction |
| 009 | Positioning Speed % | 035 | Reserved |
| 010 | Home Position/Photo Offset | 036 | Reserved |
| 011 | Homing/Jog Speed | 037 | Reserved |
| 012 | Homing/Jog Ramp | F05 | Analog Output Settings |
| 013 | Homing Mode | 038 | Analog Format |
| 014 | Ramp Form | 039 | Offset Correction |
| 015 | Pos. 0 | 040 | Gain Correction |
| 016 | Pos. 1 | 041 | Max. Correction |
| 017 | Pos. 2 | 042 | Offset Total |
| 018 | Pos. 3 | 043 | Gain Total |
| 019 | Pos. 4 | 044 | Reserved |
| 020 | Pos. 5 | 045 | Reserved |
| 021 | Pos. 6 | | |
| 022 | Pos. 7 | | |
| 023 | Pos. 8 | | |
| 024 | Pos. 9 | | |
| 025 | Batch Quantity | | |

| F06 | Command Assignment |
|-----|----------------------------|
| 046 | Key Up Function |
| 047 | Key Down Function |
| 048 | Key Enter Function |
| 049 | Input 1 Configuration |
| 050 | Input 1 Function |
| 051 | Input 2 Configuration |
| 052 | Input 2 Function |
| 053 | Input 3 Configuration |
| 054 | Input 3 Function |
| 055 | Input 4 Configuration |
| 056 | Input 4 Function |
| 057 | Reserved |
| F07 | Serial communication |
| 058 | Unit Number |
| 059 | Serial Baud Rate |
| 060 | Serial Format |
| 061 | Reserved |
| 062 | Reserved |
| 063 | Reserved |
| F08 | Special functions |
| 064 | Input Filter |
| 065 | Trigger Threshold 1 |
| 066 | Trigger Threshold 2 |
| 067 | Brightness |
| 068 | Frequency Control |
| 069 | Length Store Configuration |
| 070 | Display Time |
| 071 | Default Display |

| F09 | Keypad protection codes |
|-----|-------------------------|
| 072 | Protect Group F01 |
| 073 | Protect Group F02 |
| 074 | Protect Group F03 |
| 075 | Protect Group F04 |
| 076 | Protect Group F05 |
| 077 | Protect Group F06 |
| 078 | Protect Group F07 |
| 079 | Protect Group F08 |
| 080 | Protect Group F09 |
| 081 | Reserved |
| 082 | Reserved |
| 083 | Reserved |
| 084 | Reserved |
| 085 | Reserved |
| 086 | Reserved |
| 087 | Reserved |

The following schematics shows how in principle the parameter blocks are assigned to the various elements and functions of the controller.

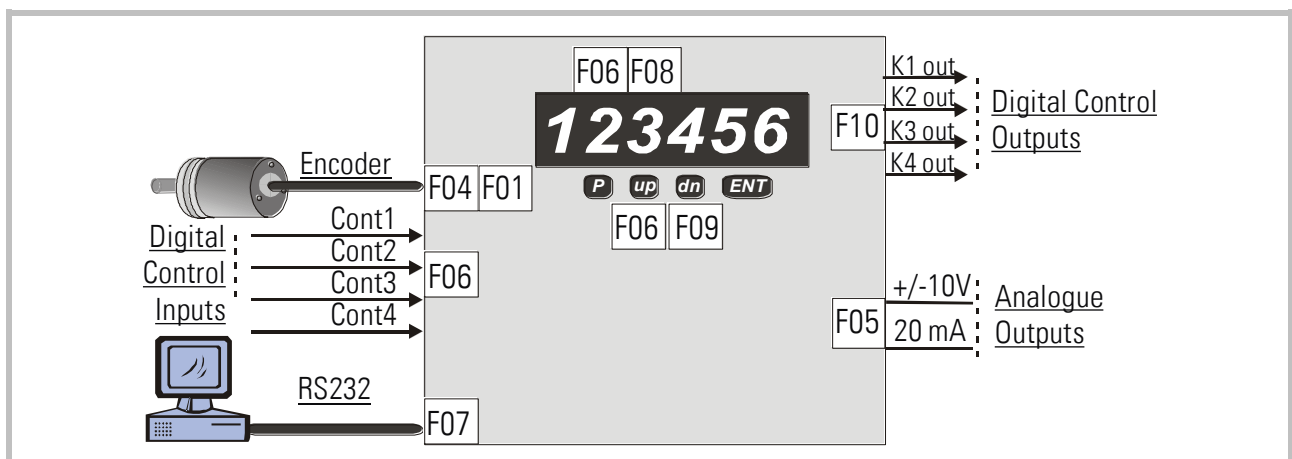

7.2 Description of the Parameters

Prior to register setting you must decide which dimensions or length units (LU) you like to use for preset of the incremental length or absolute positions. This could be 0.1mm or 1mm or 0.001 inch or any other resolution you desire. All further settings refer to the Length Units you decided to use. E.g. when you chose to set the length with a 0.1 mm resolution, 1000 LUs will represent a length of 100.0 millimeters with all further entries.

7.2.1 Position Setting

| F01 | | Range | Default |
|---------|---|-------------|---------|
| F01.000 | <p>Incremental Length: Moving length setting for incremental length operation and relative positioning. In mode 0, 1 or 4 (see parameter F02.002) the position advances always the same distance upon each start. With a PS641 variant, the value can be set by the thumbwheel switch on the front (see chapter 10.2)</p> | 1 to 999999 | 10000 |
| F01.001 | <p>Position Number: This is a pointer to an absolute position value stored in parameter F02.015 "Position 0" to F02.024 "Position 9". In mode 2 and 3 the position number determines the new absolute target position. <u>Attention:</u> In mode 3 (loop operation), this register is automatically incremented with each start and follows the branch instructions within a program loop. After an interruption of a loop cycle, be aware where the pointer is or set it to start position again.</p> | 0 to 9 | 0 |

7.2.2 Operational Settings

| F02 | | Range | Default |
|---------|--|--------------------|---------|
| F02.002 | <p>Operation Mode: This setting selects one of the five general modes of operation. See table on the next page for details.</p> | 0 to 4 | 0 |
| F02.003 | <p>Acceleration Ramp: Determines the ramp time in s for acceleration from standstill to full speed.</p> | 0.001 to 10.000 | 1.000 |
| F02.004 | <p>Deceleration Ramp: Determines the ramp time in s for deceleration from full speed to standstill.</p> | 0.001 to 10.000 | 1.000 |
| F02.005 | <p>Emergency Stop Ramp: Deceleration ramp time in s from full of speed to standstill at emergency stop. A setting of 0 will result in a jump to zero.</p> | 0 to 10.000 | 0.100 |



- The controller generates ramps of a constant gradient. Therefore, the actual ramp times depend on the ramp time settings and the positioning speed.
- You must only use acceleration and deceleration settings that the drive is really able to follow. Settings outside of the physical capability of the drive will result in malfunction or even failure of the whole system.
- Please note: When you use S-ramps (see parameter F02.014 Ramp Form), the maximum acceleration / deceleration at the steepest position of the S-profile will be 1.25 times higher than with linear ramps

Description of the diverse operation modes:

| Mode F02.002 | Function | Description |
|--------------|--|---|
| 0 | Incremental Length | F01.000 (Incremental Length) defines the next position. Target position = actual position + F01.000 Positioning direction is always forward. Residual position error at last target position remain unconsidered |
| 1 | Relative Positioning | F01.000 (Incremental Length) defines the next position with consideration of the actual position error. Target position = Last target position + F01.000 Position direction is always forward. Actual position error is considered in the next cycle. |
| 2 | Absolute Positioning | Absolute target position is selected by pointer F01.001 (Position Number) from the corresponding position value 0 to 9 (F02.015 to F02.024). A new target position can be entered either by changing the value of F01.001 (pointer selects another position value) or by entering a new position value in the position register F01.001 is actually pointing to. |
| 3 | Loop Operation | F01.001 (Position Number) will define the start position stored in F02.015 to F02.024 for a numerical sequence with consideration of branch instructions. F01.001 will be incremented or set to a branch value with every start command. |
| 4 | Incremental Length with print mark control | F01.000 (Incremental Length) defines the next position. When a signal is detected at input "Reference Position" the position cycle which is actually in progress will not be affected, but the subsequent target position will be overwritten by the print mark position, with respect of the offset set by register F02.010 "Photo Offset". |

| F02 | | Range | Default |
|---------|--|-----------------------|---------|
| F02.006 | <p>Pulses per 1000 LU: This is a scaling factor permitting to set the positions in any kind of length units, independent of the feedback resolution. Set the number of encoder pulses generated by the encoder for a distance of 1000 length units here. <u>Example:</u> You desire to have a position preset with a 0.1 mm resolution. Consequently, your length units are 0.1 mm and 1000 length units will be 100 mm. If, i.e., the encoder would generate 1380 impulses to go 100 mm forward, set the register to "1380".</p> <p>Scaling of the carriage encoder. Find out how many pulses you receive when the carriage moves 1000 length units (LU) forward and set the proper number of pulses here.</p> | 1 to 999 999 | 10 000 |
| F02.007 | <p>Position Window: This is a tolerance window around the target position for the output K3 "In Position". Setting in length units.</p> | 1 to 999 | 25 |
| F02.008 | <p>Frequency Max. Speed: Encoder feedback frequency at maximum speed of the positioning drive.</p> | 1 to 300 000 | 100 000 |
| F02.009 | <p>Positioning Speed %: This register is used to set the desired positioning speed from 0 to 100% of the maximum speed.</p> | 0.1 to 100.0 | 100.0 |
| F02.010 | <p>Home Position/Photo Offset: When during the homing sequence the drive reaches its reference position (defined by proximity switch or index pulse), the position counter will be set to this value. In mode 4, this register sets an offset to the position of the print mark (= distance between photocell and desired stop position)</p> | -99 999 to 999 999 | 0 |
| F02.011 | <p>Homing/Jog Speed: Speed set-point in Volt for jog operations and homing sequence.</p> | 0.01 to 10.00 | 1.00 |
| F02.012 | <p>Homing/Jog Ramp: Ramp time in seconds for jog operations and homing sequence with respect to speed changes between standstill and maximum speed (set-point 10 V)</p> | 0.025 to 10.000 | 1.000 |
| F02.013 | <p>Homing Mode: There are 4 modes selectable, permitting the user to choose the appropriate homing sequence. See table on next page for details.</p> | 0 to 3 | 0 |

| Homing Mode | Homing forward | Homing reverse | | |
|--|--|--|--|---|
| 0 Static homing input (Homing while input homing forw. or homing rev. is set) | | | | |
| 1 Reference position defined by proximity switch, Homing sequence without change of moving direction | | | | |
| 2 Reference position defined by proximity switch, Approach to reference position in forward direction | | | | |
| 3 Reference position defined by proximity switch, Approach to reference position in reverse direction | | | | |
| | ↑ Start homing sequence in forward direction | ↑ Set position counter to reference position value | ↑ Set position counter to reference position value | ↑ Start homing sequence in rev. direction |

| F02 | | Range | Default |
|---------|---|--------|---------|
| F02.014 | Ramp Form: Selects the shape of the ramps of the positioning speed profile: 0: Parabolic s-ramps (generally recommended with standard servo drives) 1: Linear ramps (recommended with less dynamic systems, e.g. DC drives) 2: sin ² shaped ramps (recommended with extremely dynamic servo systems) | 0 to 2 | 0 |

| F02 | | Range | Default |
|----------|--|-----------------------|---------|
| F02.015 | <p>Pos. 0: Registers to preset up to 10 fixed positions and to set branch (jump) functions for the next target position. When used as a position register, the setting range is -99 999to +99 999.</p> <p>Values from 100 000 to 100 009 serve as branch address for the position targets Pos. 0 to Pos. 9. When, in the logical sequence of positions, the unit finds a branch instruction, the next position to go will be the one defined by the position number. The starting position is defined by the setting pointer F01.001. See examples on next page.</p> | -99 999 to 100 009 | 0 |
| F02.016 | <p>Pos. 1: See Parameter F02.015</p> | -99 999 to 100 009 | 10 000 |
| F02.016 | <p>Pos. 2: See Parameter F02.015</p> | -99 999 to 100 009 | 20 000 |
| F02.017 | <p>Pos. 3: See Parameter F02.015</p> | -99 999 to 100 009 | 30 000 |
| F02.019 | <p>Pos. 4: See Parameter F02.015</p> | -99 999 to 100 009 | 40 000 |
| F02.020 | <p>Pos. 5: See Parameter F02.015</p> | -99 999 to 100 009 | 50 000 |
| F02.021: | <p>Pos. 6 See Parameter F02.015:</p> | -99 999 to 100 009 | 60 000 |
| F02.022 | <p>Pos. 7: See Parameter F02.015</p> | -99 999 to 100 009 | 70 000 |
| F02.023 | <p>Pos. 8: See Parameter F02.015</p> | -99 999 to 100 009 | 80 000 |
| F02.024 | <p>Pos. 9: See Parameter F02.015</p> | -99 999 to 100 009 | 90 000 |
| F02.025 | <p>Batch Quantity: If the batch counter reaches the value specified here the output "Batch finished" is set.</p> | 0 to 99 999 | 0 |

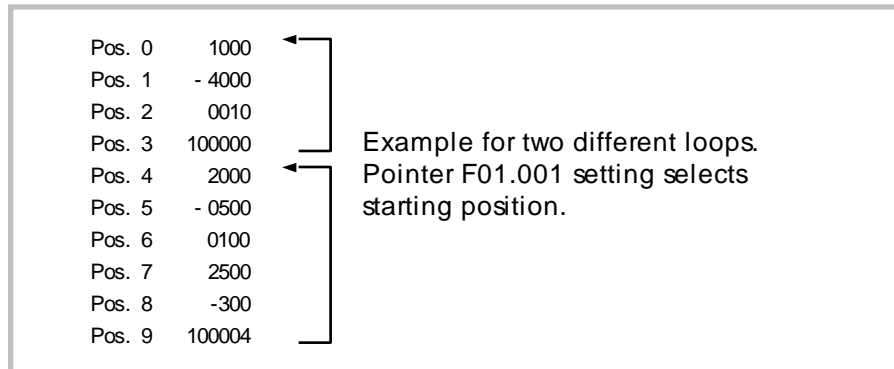
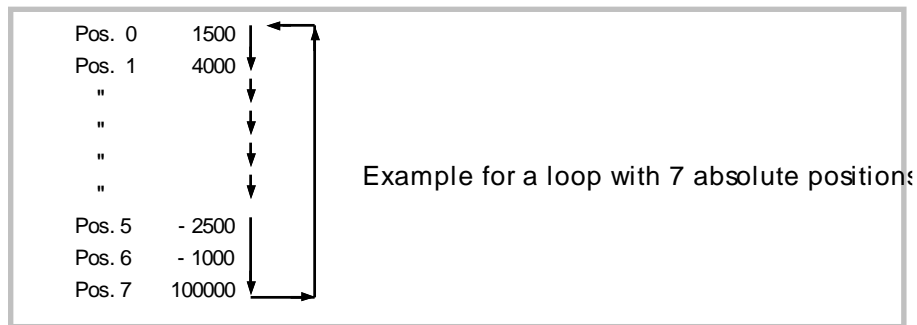

7.2.3 Definitions for the Master Encoder

| F03 | | Range | Default |
|---------|---|-------|---------|
| F03.026 | n. a.= not applicable (not used with PS units) | | |
| F03.027 | | | |
| F03.028 | | | |
| F03.029 | | | |

7.2.4 Definitions for the Slave Encoder

| F04 | | Range | Default |
|---------|---|--------|---------|
| F04.032 | Encoder properties | 0 to 1 | 1 |
| | 0= Impulses A, /A, B, /B (2 x 90°) incl. inv. | | |
| | 1= Impulses A, B (2 x 90°) without inv. | | |
| F04.033 | Edge counting | 0 to 2 | 0 |
| | 0= Single (x1) | | |
| | 1= Double (x2) | | |
| | 2= Full quadrature (x4) | | |
| F04.034 | Counting direction | 0 to 1 | 0 |
| | 0= Up when A leads B | | |
| | 1= Down when A leads B | | |
| F04.035 | n. a.. | | |

n. a. = not applicable

7.2.5 Analog output definitions

| F05 | | Range | Default |
|---------|--|---------------------------|---------|
| F05.038 | Control characteristics and Analog format | 0 to 3 | 0 |
| | 0= Output scaled for a -10 V to +10 V signal | | |
| | 1= Output scaled for a -10V to +10 V signal | | |
| | 2= Output scaled for a -20 mA to +20 mA signal | | |
| | 3= Output scaled for a -20 mA to +20 mA signal | | |
| F05.039 | Offset Correction: Digital setting of Analog offset on correction signal. | -10.000 to +10.000 (V) | 0.000 |
| F05.040 | Gain Correction: Digital setting of the proportional gain of the control loop. Setting to 2.048 results in a response of 1 mV per error bit. Recommended setting: 0.500 to 5.000 (Gain Correction / 2048 = x.xxx V per error bit). | 0 to 51.200 | 2.000 |
| F05.041 | Max. Correction: Limitation of the output voltage of the correction signal (correction will not exceed this setting) | 0 to 10.000 (V) | 2.000 |
| F05.042 | Offset Total: Digital setting of analog offset of the overall analog output signal. | -10.000 to +10.000 (V) | 0.000 |
| F05.043 | Gain Total: Sets the full-scale output voltage at maximum speed, i.e. 9,000 means 9 V at max. speed | 0 to 11.000 (V) | 10.000 |

n. a. = not applicable

7.2.6 Key command assignments

| F06 | | Range | Default |
|---------|---|---|---|
| F06.046 | Function assignment to key „UP“ | | 0 to 16 For more details about these functions see section 8.1 |
| | 0= | No function | |
| | 1= | Reset | |
| | 2= | Start | |
| | 3= | Homing forward | |
| | 4= | Homing reverse | |
| | 5= | n. a. | |
| | 6= | Emergency Stop | |
| | 7= | Store to EEPROM | |
| | 8= | Scroll Display | |
| | 9= | n.a. | |
| | 10= | Jog forward | |
| | 11= | Jog reverse | |
| | 12= | n. a. | |
| | 13= | n. a. | |
| | 14= | Read front thumbwheels (model PS641 only) | |
| | 15= | Clear Batch Counter | |
| 16= | n. a. | | |
| F06.047 | Function assignment to key „DOWN“ | | 0 to 16 0 |
| | | See key „UP“ | |
| F06.048 | Function assignment to key „ENTER“ | | 0 to 16 0 |
| | | See key „UP“ | |

n. a. = not applicable

7.2.7 Characteristics and functions of the Control Inputs

| F06 | | Range | Default | |
|---------|--|--|------------------------|---|
| F06.049 | Switching characteristics of input „Cont.1“ | | 0 ... 7 | 0 |
| | 0= | NPN (switch to -), function active LOW | | |
| | 1= | NPN (switch to -), function active HIGH | | |
| | 2= | NPN (switch to -), rising edge | | |
| | 3= | NPN (switch to -), falling edge | | |
| | 4= | PNP (switch to +), function active LOW | | |
| | 5= | PNP (switch to +), function active HIGH | | |
| | 6= | PNP (switch to +), rising edge | | |
| F06.050 | Function assignment to input „Cont.1“ | | 0 ... 16 | 6 |
| | 0= | No function | | |
| | 1= | Reset | | |
| | 2= | Start | | |
| | 3= | Homing forward | | |
| | 4= | Homing reverse | | |
| | 5= | n.a. | | |
| | 6= | Emergency Stop | | |
| | 7= | Store to EEPROM | | |
| | 8= | Scroll Display | | |
| | 9= | Parameter Input Disable | | |
| | 10= | Jog forward | | |
| | 11= | Jog reverse | | |
| | 12= | Reference Position (only "Cont. 1" to "Cont. 3") | | |
| | 13= | n.a. | | |
| | 14= | Read front thumbwheels (model PS641 only) | | |
| 15= | Clear Batch Counter | | | |
| 16= | n.a. | | | |
| | | For more details about these functions see section 8.1 | | |
| F06.051 | Switching characteristics of input „Cont.2“ | | See „Cont.1“ (F06.049) | |
| F06.052 | Function assignment to input „Cont.2“ | | See „Cont.1“ (F06.050) | |
| F06.053 | Switching characteristics of input „Cont.3“ | | See „Cont.1“ (F06.049) | |
| F06.054 | Function assignment to input „Cont.3“ | | See „Cont.1“ (F06.050) | |
| F06.055 | Switching characteristics of input „Cont.4“ | | 0 – 3 |  no edge-triggered functions are possible with Cont.4 |
| | 0= | NPN (switch to -) function active LOW | | |
| | 1= | NPN (switch to -) function active HIGH | | |
| | 2= | PNP (switch to +), function active LOW | | |
| | 3= | PNP (switch to +), function active HIGH | | |
| F06.056 | Function assignment to input „Cont.4“ | | See „Cont.1“ (F06.050) | |

n. a. = not applicable



- Unconnected NPN inputs are always HIGH (internal pull-up resistor)
- Unconnected PNP inputs are always LOW (internal pull-down resistor)
- The function "Reference Position" can be assigned to inputs "Cont. 1" to "Cont.3". If this function is used for the homing sequence the corresponding input must operate statically, i. e. the corresponding parameter F06.049, F06.051 or F06.053 must be set to 0, 1, 4 or 5!

7.2.8 Serial communication parameters

| F07 | | Range | Default |
|------------------------------|-------------------------------------|-----------|---------|
| F07.058 | Serial device address (unit number) | 11 ... 99 | 11 |
| F07.059 | Serial baud rate | 0 ... 6 | 0 |
| | 0= 9600 Baud | | |
| | 1= 4800 Baud | | |
| | 2= 2400 Baud | | |
| | 3= 1200 Baud | | |
| | 4= 600 Baud | | |
| | 5= 19200 Baud | | |
| F07.060 | Serial data format | 0 ... 9 | 0 |
| | 0= 7 Data, Parity even, 1 Stop | | |
| | 1= 7 Data, Parity even, 2 Stop | | |
| | 2= 7 Data, Parity odd, 1 Stop | | |
| | 3= 7 Data, Parity odd, 2 Stop | | |
| | 4= 7 Data, no Parity, 1 Stop | | |
| | 5= 7 Data, no Parity, 2 Stop | | |
| | 6= 8 Data, Parity even, 1 Stop | | |
| | 7= 8 Data, Parity odd, 1 Stop | | |
| | 8= 8 Data, no Parity, 1 Stop | | |
| 9= 8 Data, no Parity, 2 Stop | | | |

7.2.9 Special functions

| F08 | | Range | Default |
|---------|---|-----------------|---------|
| F08.064 | Digital input filter: must be set to "0". | 0 ... 3 | 0 |
| F08.065 | Trigger threshold for encoder1 inputs *) | 30 ... 250 | 166 |
| F08.066 | Trigger threshold for encoder2 inputs *) | 30 ... 250 | 166 |
| F08.067 | Brightness of the 7-segment LED display | 0 ... 4 | 0 |
| | 0= 100% of maximum brightness | | |
| | 1= 80% of maximum brightness | | |
| | 2= 60% of maximum brightness | | |
| | 3= 40% of maximum brightness | | |
| | 4= 20% of maximum brightness | | |
| F08.068 | Frequency Control: must be set to "0" | 0 ... 1 | 0 |
| F08.069 | Length Storage | 0 ... 1 | 0 |
| | 0= Incremental length set by the "Direct Fast Access" menu (see chapter 6.3) is only temporary active until next power-down. | | |
| | 1= Incremental length set by the "Direct Fast Access" menu (see chapter 6.3) is stored to EEPROM for enduring use. | | |
| F08.070 | Display Time: Update time (sec.) for display only | 0.005 ... 9.999 | 0.050 |
| F08.071 | Default Display: Number of actual value displayed by the unit after power up (see table in chapter 8.1 at description of Scroll Display command) | 0 ... 8 | 0 |

*) Must be set to the default value (166) for any kind of input signals, except for single-ended TTL signals which require a setting of 35.

7.2.10 Keypad protection codes

| F09 | | Range | Default |
|---------|---------------------|--|---------|
| F09.071 | Protected group F01 | 0 = no protection 1 – 999 999 = Protection code for the actual parameter group | 0 |
| F09.072 | Protected group F02 | | |
| F09.073 | Protected group F03 | | |
| F09.074 | Protected group F04 | | |
| F09.075 | Protected group F05 | | |
| F09.076 | Protected group F06 | | |
| F09.077 | Protected group F07 | | |
| F09.078 | Protected group F08 | | |
| F09.079 | Protected group F09 | | |

8 Description of Commands and Outputs

8.1 Commands

| No. | Command | Description | Assignment to | |
|-----|-------------------------|--|---------------|-------|
| | | | Keypad | Input |
| 1 | Reset | Sets the internal differential counter and the analog correction signal to zero, i. e. the position control runs in open loop operation. Furthermore this command resets error conditions and clears the corresponding error messages (see also chapter 8.4 / Error Messages). | yes | yes |
| 2 | Start | Start next positioning cycle. | yes | yes |
| 3 | Homing forward | Start homing in forward direction. | yes | yes |
| 4 | Homing Reverse | Start homing in backward direction. | yes | yes |
| 5 | n. a. | | no | no |
| 6 | Emergency Stop | Any positioning in progress will be aborted and the drive will go to standstill using the Emergency Stop Ramp setting. | yes | yes |
| 7 | Store EEPROM | Stores actual operational settings to the EEPROM, so they remain available also after power down. | yes | yes |
| 8 | Scroll Display | Selects the source of the digital display. See chapter 8.3 Display for details. | yes | yes |
| 9 | Keyboard Disable | Lock the keyboard against the access on parameters, but keyboard commands are executed. | no | yes |
| 10 | Jog Forward | Moves the drive in one or the other direction (Jog speed register settable). After termination of a Jog command, the drive will be held again in its new position under closed-loop control. From this new position the drive will also start to execute the next positioning cycle. The Jog inputs are only active when the drive has finished a positioning cycle and is stopped. | yes | yes |
| 11 | Jog Reverse | | yes | yes |

| No. | Command | Description | Assignment to | |
|-----|----------------------------|---|---------------|-------|
| | | | Keypad | Input |
| 12 | Reference Position | In modes 0 – 3, this input receives a signal from a limit switch or a proximity to define the reference position. Depending on the selected home mode, the drive will stop here, the output "Homing Done" will switch on and the position counter will be set to the value of register F02.010 "Home Position" In mode 4, this input receives a signal from a photocell or print mark sensor, and the rising edge will correct the next target position in order to match the print mark position. | yes | yes |
| 13 | n. a. | n. a. | | |
| 14 | Read Thumbwheels | Reads and activates the incremental length setting from the front thumbwheel switches (model PS641 only) | yes | yes |
| 15 | Clear Batch Counter | Resets the internal batch counter to zero. | yes | yes |
| 16 | n. a. | n. a. | no | no |

n. a. = not applicable

8.2 Outputs

| No. | Output | Terminal |
|-----|--|----------|
| K1 | Batch Finished: The batch counter has reached the value set by parameter F02.025 (Batch Quantity). | X2 / 26 |
| K2 | Homing done: Upon power up, this output remains low until a homing cycle has been executed and the system has been calibrated by moving to its reference position. The output stays high all the time, unless a new homing cycle is started. | X2 / 25 |
| K3 | In Position: This output continuously compares the actual position to the actually required target position +/- a programmable position window. It goes high upon coincidence. It goes low again on next start command. | X1 / 10 |
| K4 | Moving: This output is high whenever the drive is moving during a positioning cycle | X1 / 9 |
| - | Unit Ready: This announces that the unit is ready to run. On power up, this output is "Low" for about three seconds to allow the power supply to settle, and then switches to "High". | * |
| - | Max. Correction: Indicates that the limitation of the correction voltage has been activated to keep the correction inside "Max. Correction". | * |
| - | Emergency Stop: The emergency stop function has been activated. The drive will ramp down to standstill using the Emergency Ramp setting. | * |
| - | Error: If there is a fault during the operation this output is set. (See chapter 8.4 "Error Messages") | * |

*) These outputs can only be read via serial interface

8.3 Display of Actual Values

During normal operation it is possible to display an actual value. Two LEDs at the front panel indicate the actual value displayed. You can scroll the actual value on the display by Scroll Display command, which can be assigned either to a key or to an input. Parameter F08.071 "Default Display" selects the actual value to be displayed after power up of the unit.

| Nr. | Display | L1 (red) | L2 (yellow) |
|-----|--|----------|-------------|
| 0 | Display OFF (only two decimal points are lit to indicate operation state) | OFF | OFF |
| 1 | Position error (differential counter) | OFF | OFF |
| 2 | Position error (bar graph display, see diagram below) | OFF | OFF |
| 3 | Actual frequency (Hz) | ON | OFF |
| 4 | Actual position in encoder increments | OFF | ON |
| 8 | Batch Counter (Incremented by each positioning operation; can be reset to zero by the command "Clear Batch Counter") | ON | ON |

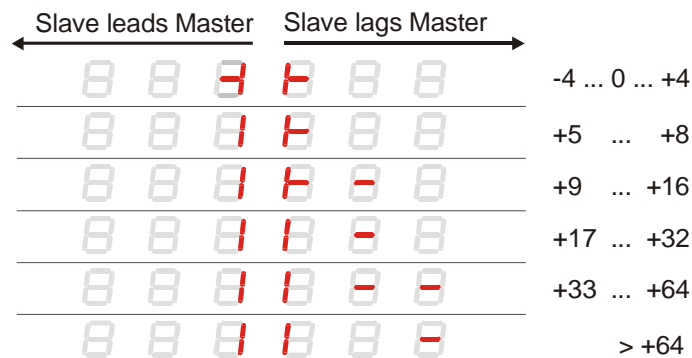

Bar graph display with reference to the actual position error

The diagram shows positive errors only (Slave lags position set-point). Negative errors are mirror-inverted.

8.4 Error Messages

Upon detection of an error, the drive remains in a closed-loop standstill at the actual position. Output "Error" switches to high and the unit displays a flashing error message "Error..." indicating the error number.

To clear an error state either set "Reset" command or cycle the power supply of the unit. Please note that the unit will immediately return to the error state if the cause for the error has not been eliminated.

| Error No. | Error Description |
|-----------|---|
| Error 0 | The reason for the error has been rectified (e. g. power supply voltage recovered above minimum level) but the error has not yet been cleared by input "Reset". |
| Error 1 | Power Low: The power supply voltage is too low. This error is reset automatically when the power supply voltage recovers and exceeds the minimum power supply voltage level. |
| Error 2 | Val. Range exceed: An internal parameter value is out of range |
| Error 3 | Invalid Position Setting: At loop operation (mode 3) the branch address does not refer to a new position but again to a branch address. |

9 Steps for Commissioning

For easy and uncomplicated commissioning of the PS340 / 641 controllers you need a PC with the actual operator software OS 6.x. You can download this software and full instructions, free of charge, from our homepage www.motrona.com.

In exceptional cases where no PC or laptop is available for commissioning you can set all parameter values also by keypad as shown in chapter 6. In this case please define the encoder counting direction as described in chapter 9.3.

Connect your PC to the controller as shown in section 4.6 and start the OS 6.x software. The following screen will appear:

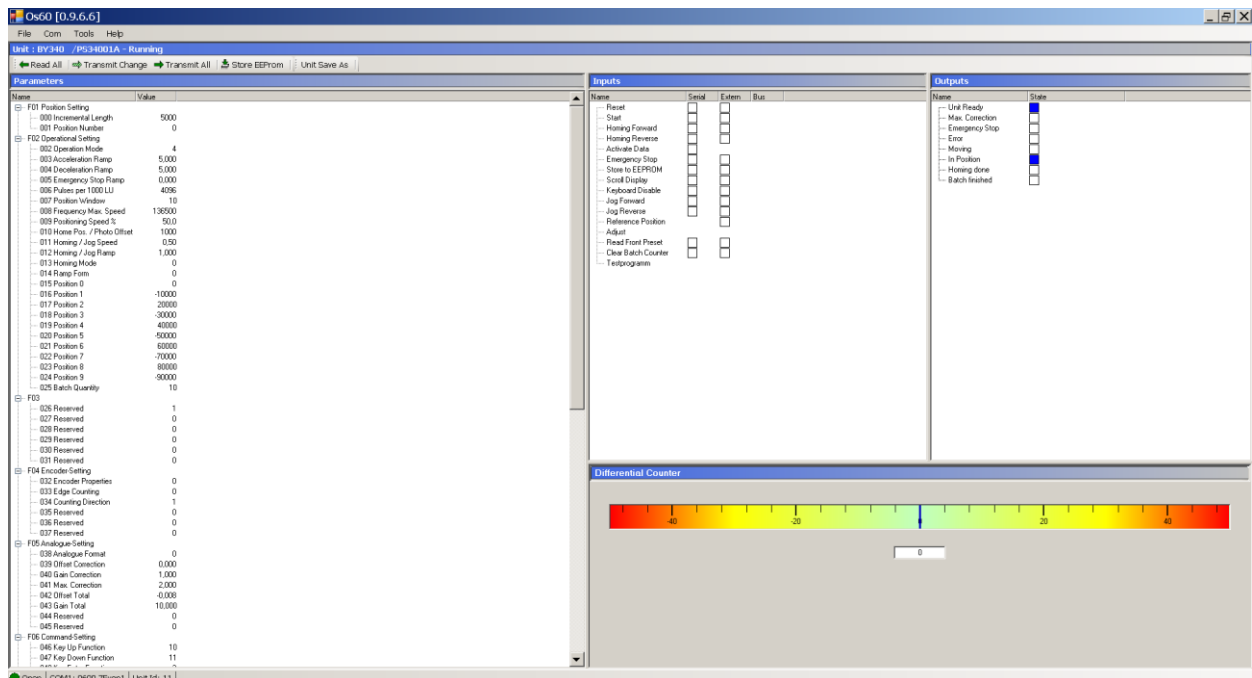

When you find the mask blank with the indication „Unit: Searching Unit...“ at the top instead of the device version, please click to the „Com“ menu and check the serial settings of your PC.

Set all parameters in the edit field according to your needs, following the hints given in this manual. The following parameters should initially be set to the values as shown:

| Number | Register | Initial Setting |
|---------|-------------------|-----------------|
| F02.009 | Positioning Speed | 20.0* |
| F05.040 | Correction Gain | 1.000 |

*) Determines the speed of the positioning drive in the following adjust menu (can be set higher or lower than 20.0% according to your needs)

After entry of all parameters click to "Transmit Change" or "Transmit All" followed by "Store EEPROM" to store all parameters to the PS340 or PS641 controller.



- At this time, the positioning drive must be adjusted to proper and stable operation over the full speed range. The drive controller must provide a maximum of dynamics and response (set ramps to zero, switch off any integral or differential component of the internal speed control loop, i.e. operate the drive with proportional speed control only, with the proportional Gain set as high as possible).
- For the set-up procedure it is recommended to mechanically disconnect the motor shaft from the machine, so you can run the motor continuously and need not to observe the mechanical limitations of the machine

9.1 Use of the adjust menu

The settings of the direction of rotation and the controller gain is carried out by means of the adjust program which can be opened in the menu "Tools" with "OS6 Adjust Tools" and started with the button "Start".

For reasons of safety the positioning drive should be disabled at that time.

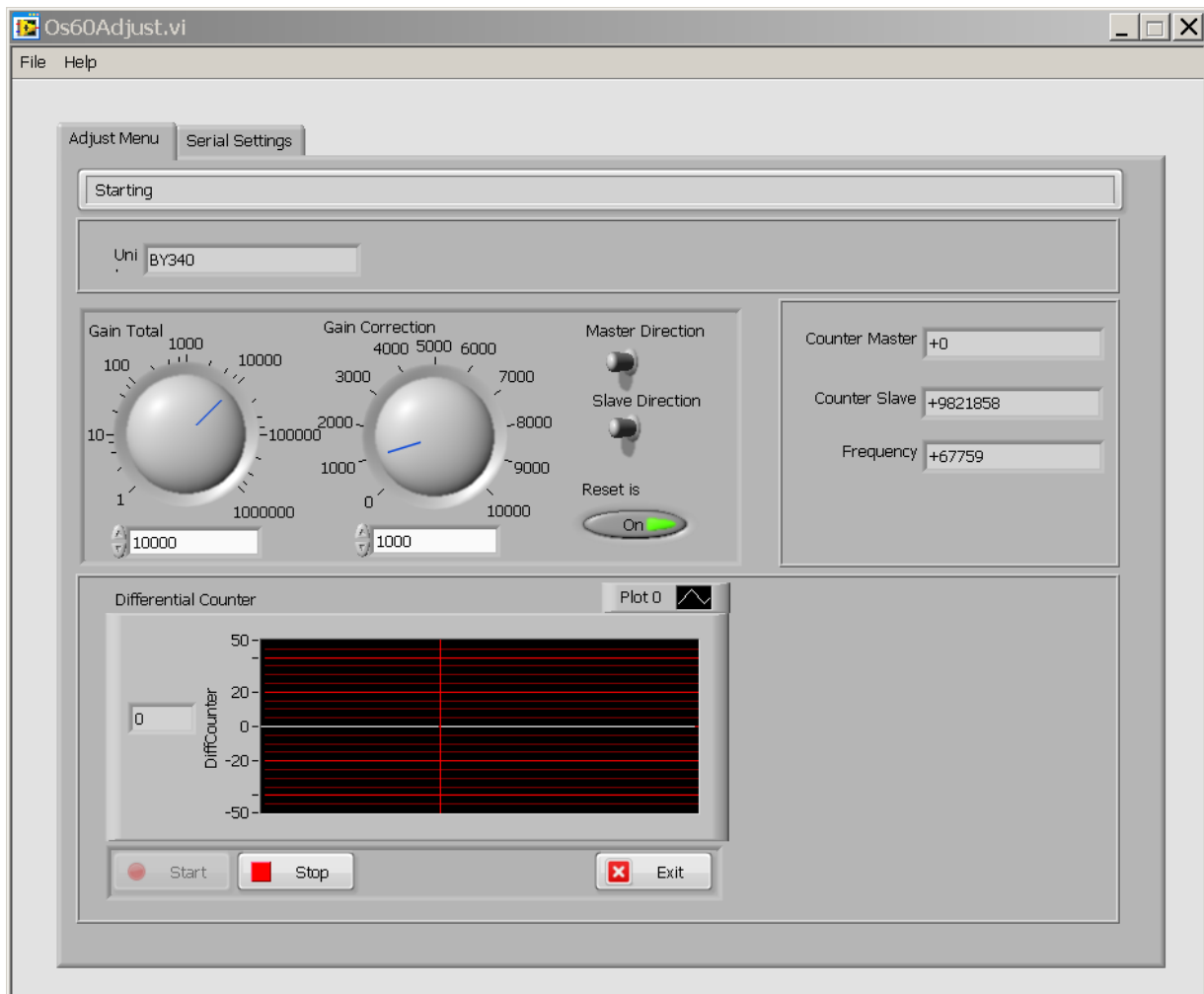

9.2 Set Directions of Rotation

The direction of rotation must be defined now. Move the positioning drive into the **forward** direction (this is the direction to which the drive moves with a **positive** set-point) either

- manually or
- with an external positive set-point or
- by enabling the positioning drive. In this case the drive gets a speed set-point from PS340/PS641 corresponding to the value of parameter F02.009 "Positioning Speed".

Observe in the small monitor window right on the screen behind "Counter Slave" the displayed count. This counter must **count upwards** (increase) and the displayed encoder frequency must be positive.

If the counter counts downward and the frequency is negative, please click on the switch "Slave Direction" to reverse the counting direction. The "Master Direction" item has no function in the adjust menu of PS340/PS641 units. Moreover, if you are using the speed set-point by PS340/PS641 you can use the displayed frequency value to check the settings of the parameter F02.008 "Frequency Max. Speed": The displayed encoder frequency must correspond to the speed set by parameter F02.009 "Positioning Speed".

9.3 Set Directions of Rotation without PC

If there is no PC or Laptop available the direction of rotation of the encoder of the positioning drive can be adjusted alternatively:

First of all the position error (differential counter) must be shown on the display of the device (see chapter [8.3](#)); with factory settings the default display value is the differential counter. Then you must move the positioning drive to **forward direction** (this is the direction to which the drive moves with a **positive speed set-point**). The differential counter thereby must **count downwards**, i. e. the position error must decrement to negative values. If the differential counter counts upwards, please reverse the counting direction by parameter F04.034 "Counting Direction".

9.4 Setting of the Proportional Gain

The register "Gain Correction" determines how strong the controller responds to position and speed errors of the drive. In principle, this setting therefore should be as high as possible. However, depending on dynamics and inertia of the whole system, too high gain values will produce stability problems.

Please try to increase the setting of Correction Gain from 1.000 to 1.500, 2.000, 2.500, 3.000 etc. However, as soon as you find unsteady operation, noise or oscillation, you must reduce the setting again accordingly.

At this point all important settings are done. Please stop the adjust program by button "Stop" and leave it by button "Exit". The system is ready for operation now and you can carry out the first positioning.

9.5 Optimization of the controller

It is recommended to carry out several positioning cycles with practical speed settings to check the dynamic stability of the system with the actual parameter settings.

In doing so, please observe the positioning error (differential counter) on the PC operating software or on the display of the device:

- If during forward acceleration the position error reaches high positive values and the bar graph moves to the extreme right position, this indicates that the drive cannot follow the acceleration ramp and you should increase the parameter F02.003 "Acceleration Ramp".
- If during forward deceleration the position error reaches high negative values and the bar graph moves to the extreme left position, this indicates that the drive cannot follow the deceleration ramp and you should increase the parameter F02.004 "Deceleration Ramp".

Where you find your position error remains small enough all the time, you are free to decrease the acceleration and deceleration ramp time settings. This will cause steeper ramps and therefore decrease the total positioning cycle time.

This concludes the procedure of commissioning of your positioning system. We recommend saving all parameter settings on hard disc or disc and adding it to the machine documentation. In case of repeat applications (machine with similar specifications), or after exchange of the controller, you just need to download the settings to be immediately ready to go

10 Appendix for model PS641

10.1 Relay Outputs

While model PS340 provides high-speed transistor outputs only, model PS641 provides four additional relay outputs, operating in parallel to the high-speed transistor outputs K1 to K4.

All electrical connections of PS641 are fully similar to PS340, except that with PS641 models the back plane is equipped with an additional terminal strip X3 providing the relay connector:

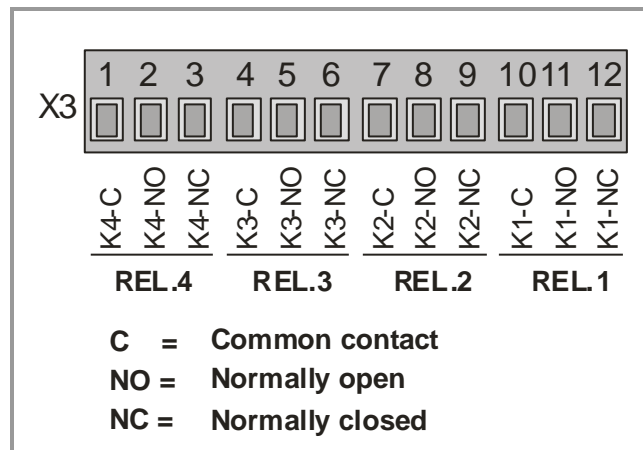

10.2 Front Thumbwheel Switches

Moreover, the PS641 models provide thumbwheel switches on the front panel, for simple and easy setting of the incremental length.

This is how the front switches work:

- Upon power-up the unit will read the thumbwheel settings and overwrite the incremental length setting of F01.000 correspondingly, i.e. the system moves the length set by the front thumbwheels.
- When during operation you change the thumbwheel setting, this will not affect the incremental length until you apply a "Read Thumbwheel" command to the unit. You can assign this command to either one of the front keys or to one of the Control Inputs, as shown under sections [7.2.6](#), [7.2.7](#) and [8.1](#).
- When the front thumbwheels are all set to zero, the controller will automatically use the incremental length set at parameter F01.000 by keypad or PC operator software.

11 Technical Specifications

| | |
|--|--|
| Power supply: | Input voltage (AC): 24 VAC +/- 10 % Input voltage (DC): 17 ... 40 VDC Protection circuit:: reverse polarity protection Consumption: 100 mA at 24 VDC (unloaded encoder supply) Connections: screw terminal, 1.5 mm ² |
| Encoder supply: | Number of aux. voltages: 2 (each double-performed) Output voltage 1: 24 VDC Output current 1: max. 120 mA each Output voltage 2: 5.2 VDC Output current 2: max. 150 mA each Connections: screw terminal, 1.5 mm ² |
| Incremental input: | Signal levels: HTL: LOW 0 ... 2 V, HIGH 10 ... 30 V TTL: LOW 0 ... 0.8 V, HIGH 3 ... 5 V RS422: Differential voltage > 1 V Channels: symmetrical: A, /A, B, /B or asymmetrical: A, B Frequency: RS422 / TTL symmetrical: 300 kHz HTL or TTL asymmetrical: 200 kHz Internal resistance: Ri ≈ 8.5 kOhm Connections: screw terminal, 1.5 mm ² |
| Control inputs: | Number of inputs: 4 (configurable) Signal levels: HTL: LOW 0 ... 2.5 V, HIGH 10 ... 30 V Characteristic: NPN / PNP / Namur Internal resistance: Ri ≈ 3.3 kOhm Min. pulse time: 50 μs Connections: screw terminal, 1.5 mm ² |
| Control outputs: | Number of outputs: 4 fast transistor outputs **) Protection circuit: short circuit proof Characteristic: PNP, 5 ... 30 V Output current: 350 mA each Reaction time: < 1 ms *) Connections: screw terminal, 1.5 mm ² |
| Relay outputs: (only with Version PS641) | Number of outputs: 4 potential-free changeovers **) Switching capacity: 250 VAC / 1 A / 250 VA or 100 VDC / 1 A / 100 W Reaction time: ca. 10 ms Connections: screw terminal, 1.5 mm ² |
| Analog outputs: | Number of outputs: 1 x voltage output and 1 x current output Voltage output: +/- 10 V (load max. 2 mA) Current output: +/- 20 mA (burden max. 270 Ohm) Resolution: 14 Bit (13 Bit + sign) Overall response time: < 1 ms *) Connections: screw terminal, 1.5 mm ² |
| Serial interface: | Format: RS232 Baud rate (selectable): 600, 1200, 2400, 4800, 9600, 19200, 38400 Baud Connections: screw terminal, 1.5 mm ² |

*) Continuous serial communication may temporary increase response times

**) Diode or RC filtering is mandatory when switching inductive loads

Continuation "Technical Specifications"

| | | |
|----------------------------------|--|---|
| Housing: | Type: Material: Montage: Dimensions PS340: Dimensions PS641: Protection class PS340: Protection class PS641: Weight PS340: Weight PS641: | Norly UL94-V-0 plastic panel Cut out: 91 x 44 mm / 3.59 x 1.73 inch (w x h) Outer dimensions: 110 x 48 x 141 mm resp. 4.33 x 1.89 x 5.55 inch (w x h x d) Cut out: 89 x 91 mm / 3.50 x 3.59 inch (w x h) Outer dimensions: 110 x 96 x 141 mm resp. 4.33 x 3.78 x 5.55 inch (w x h x d) front: IP 65 / rear: IP20 front: IP 20 / rear: IP20 (PS641 front can be upgraded to IP65 by using the optional plexiglass cover part # 640264) ca. 250 g ca. 370 g |
| Ambient temperature: | Operation: Storage: | 0 °C ... +45 °C / +32 ... +113 °F (not condensing) -25 °C ... +70 °C / -13 ... +158 °F (not condensing) |
| Conformity and standards: | EMC 2004/108/EC: LV 2006/95/EC: Guideline 2011/65/EU: | EN 61000-6-2, EN 61000-6-3, EN 61000-6-4 EN 61010-1 RoHS-conform |

12 Dimensions

12.1 Model PS340:

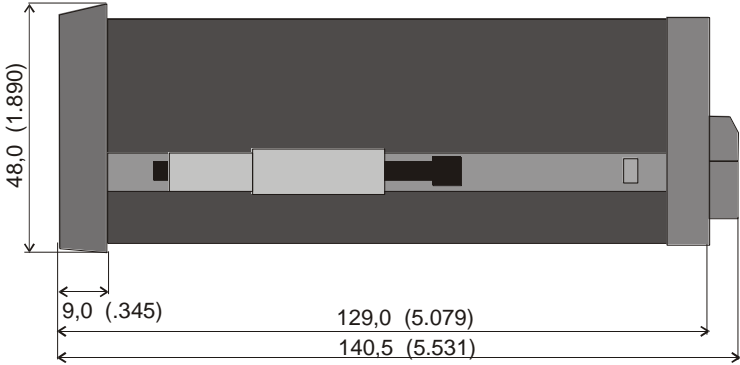
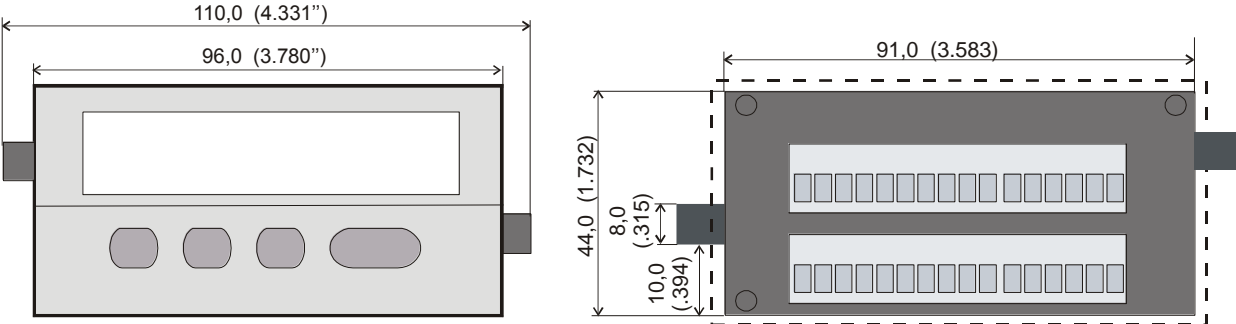

Panel cut out: 91 x 44 mm (3.583 x 1.732")

12.2 Model PS641:

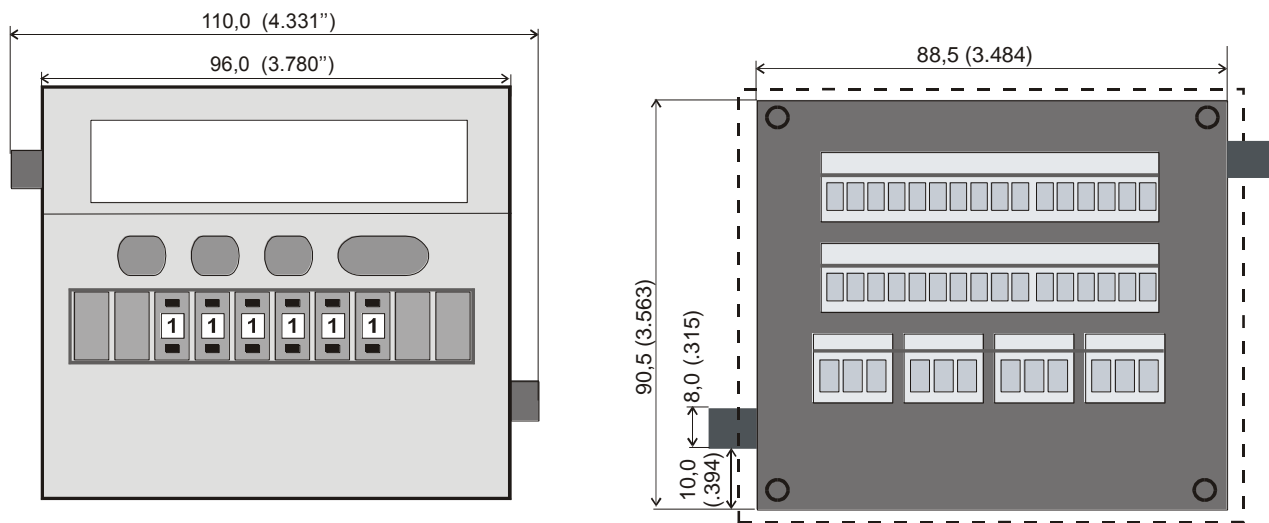

**With optional plexi glass cover
 for protection class IP65
 (motrona part # 64026)**

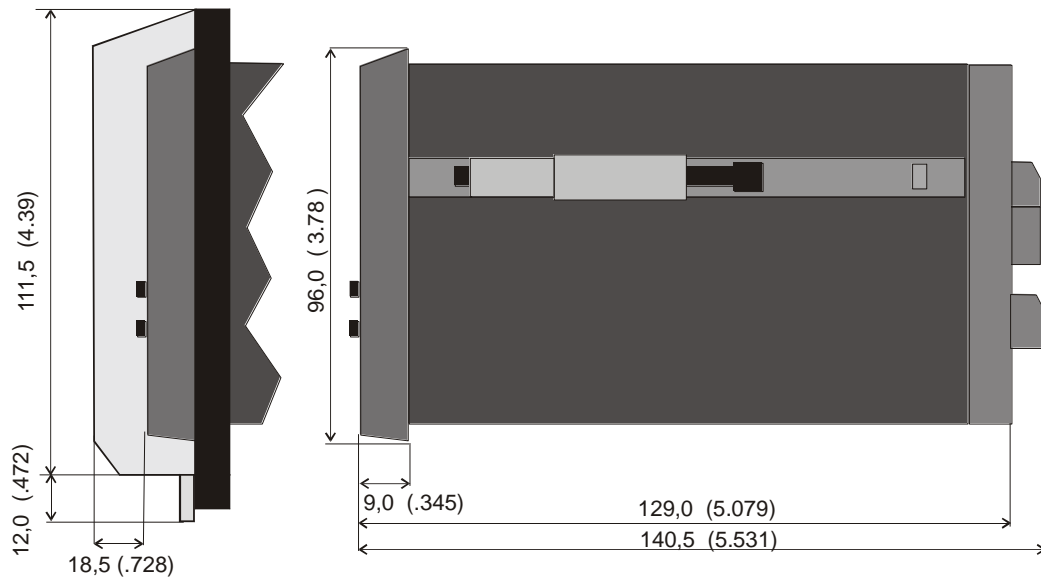

Panel cut out (b x h): 89 x 91 mm (3.504" wide x 3.583" high)