

GV 470 / GV 471

Impulse Splitters for Incremental Encoders, with 4 or 8 Output Channels

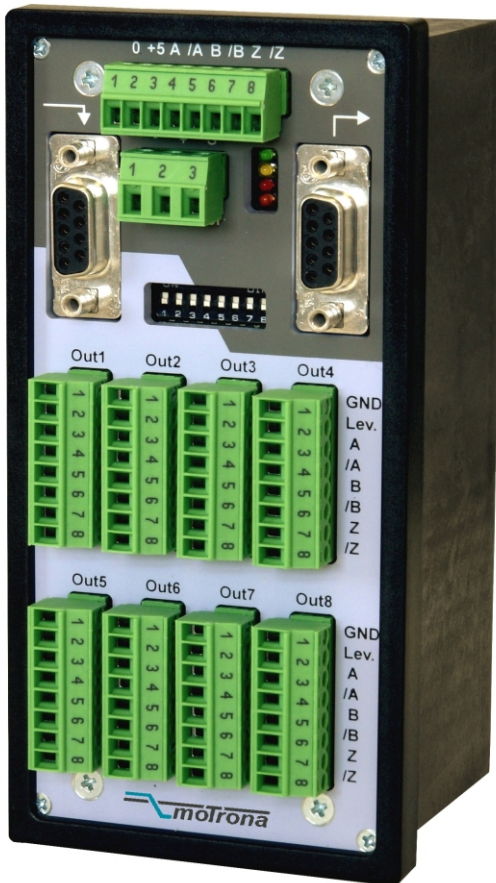

GV 470: Splitter with 8 Output Channels



GV 471: Splitter with 4 Output Channels

Operating Instructions



Safety Instructions

- This manual is an essential part of the unit and contains important hints about function, correct handling and commissioning. Non-observance can result in damage to the unit or the machine, or even in injury to persons using the equipment !
- The unit must only be installed, connected and activated by a qualified electrician
- It is a must to observe all general and also all country-specific and application-specific safety standards
- When this unit is used with applications where failure or maloperation could cause damage to a machine or hazard to the operating staff, it is indispensable to meet effective precautions in order to avoid such consequences
- Regarding installation, wiring, environmental conditions, screening of cables and earthing, you must follow the general standards of industrial automation industry
- - Errors and omissions excepted –

Version:	Description
GV47001a/Feb06/HK	First edition
GV47001b/Feb06/HK	Improved block diagram
GV47001c/April09/HK	Extensions for GV471

Table of Contents

1.	Introduction and Block Diagram	4
2.	Electrical Connections and LED Function	6
2.1.	Power Supply and LEDs	6
2.2.	Auxiliary Encoder Supply	6
2.3.	Impulse Inputs	7
2.3.1.	TTL encoders with differential outputs (suitable for signal levels up to 5.5 volts according to RS422 standard)	7
2.3.2.	Encoders with single-ended outputs, without inverted signals (suitable for HTL levels >15 volts only)	7
2.3.3.	HTL encoders with differential outputs (suitable for signal levels from 10 to 30 volts)	7
2.3.4.	Differential signals for encoder channels A, /A, B, /B but single-ended marker pulse from proximity switch or photocell	8
2.4.	The Outputs	9
2.5.	Cascading of Several Units and Encoder Select Function	9
3.	Technical Specifications	11
4.	Dimensions	12

1. Introduction and Block Diagram

GV470 and GV471 represent a series of incremental encoder splitters with a most compact, space-saving design and with most versatile technical features. Both models are fully identical except for the number of output channels (4 or 8 channels)

Both products provide potential separation between the input and the outputs, whilst the outputs among each other and the power supply use the same common GND potential.

**Where an overall potential separation between all circuits is required,
please refer to models GV480 and GV481**

The encoder input is switch-selectable for operation with either standard RS422 signals, with differential TTL or HTL signals or with single-ended HTL encoder signals. All encoder outputs provide push-pull drivers with individual assignment of the output level for each of the output channels.

Separate cascading ports provide easy cascading of multiple units without loss of regular encoder outputs. Furthermore, cascaded units allow selection and commutation between different encoder inputs.

The adjoining block diagram clearly explains the principle of operation and the potential conditions between all circuits. For simplification the illustration shows only two of the outputs, since all outputs are fully identical.

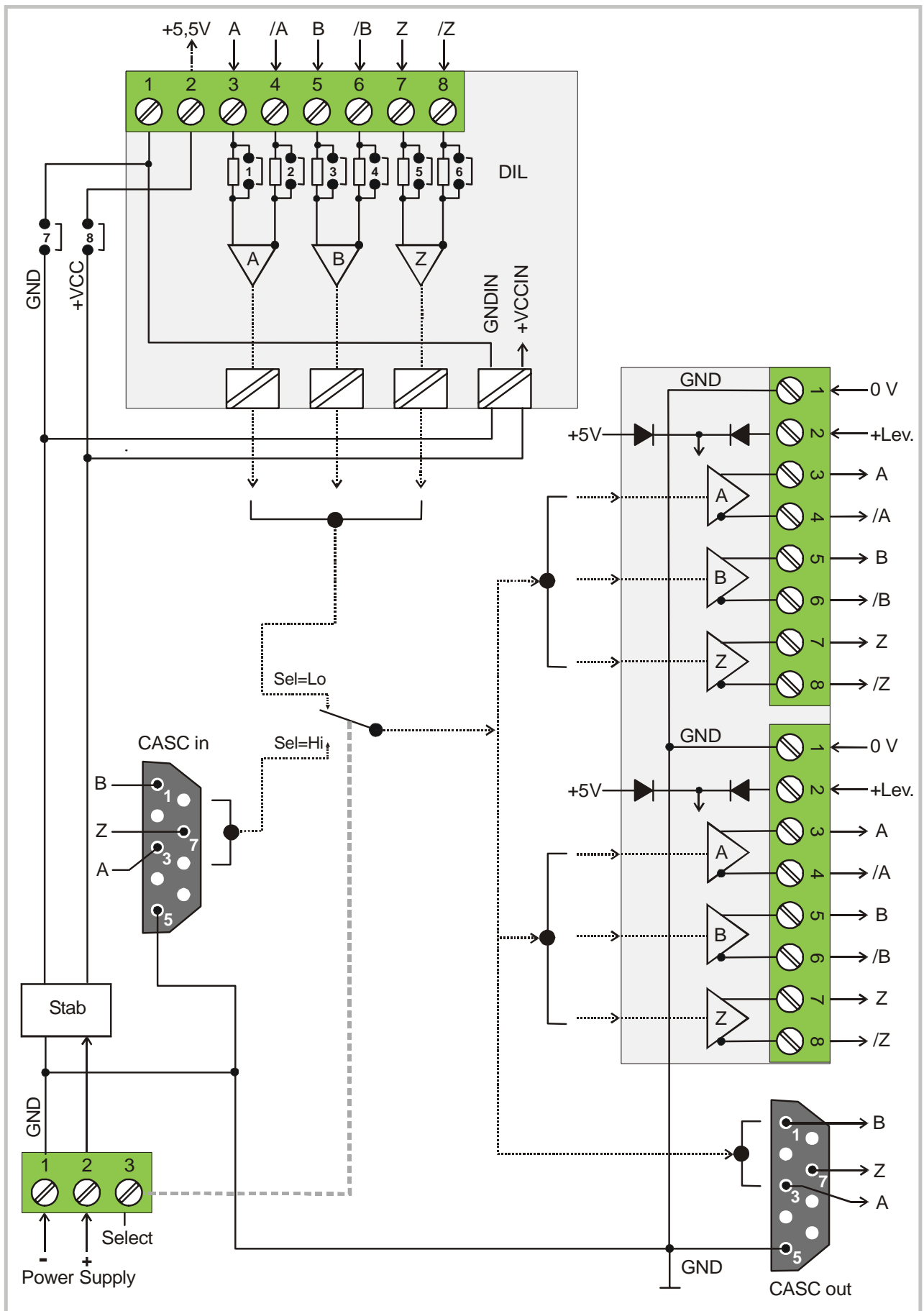

2. Electrical Connections and LED Function

2.1. Power Supply and LEDs

The unit provides a 3-position screw terminal strip for supply from a 10 – 30 volts DC power unit. The current consumption is approx. 100 mA (no-load operation).

The “Select” input terminal provides selection of the desired source encoder. Details will be described later.

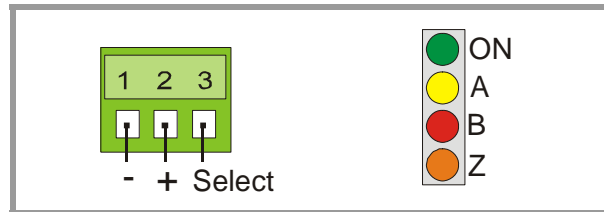

The upper LED (green) signals that power is applied to the unit.

The lower LEDs (yellow, red, orange) signal the actual logical states of the input channels A, B and Z. With very low input frequencies it is possible to visually check the input pulses, the phase displacement A/B and the index pulse function of an encoder.

2.2. Auxiliary Encoder Supply

The input encoder must be connected to the 8-position input terminal strip.

Depending on the application and the encoder type, one of the following options will apply for the power supply of the encoder:

- a) Remote supply via separate source
- b) Same power source that also supplies the GV470 unit (10 - 30 VDC) *)
- c) Use of the built-in auxiliary 5.5 volts power supply (terminal 2 of the input connector) *)



When the built-in 5,5 volts power should be used to supply the encoder, positions 7 and 8 of the DIL switch have to be set to "ON".

*) Suspends the galvanic separation of the input against outputs and power supply



2.3. Impulse Inputs

The 8-position DIL switch on the front side provides setting of the desired signal formats and levels. These settings are separately for each of the channels A / B / Z (see block diagram). For simplification, a short form of the four most common applications is shown below, with the encoder supply omitted:

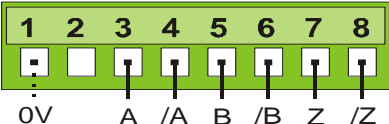
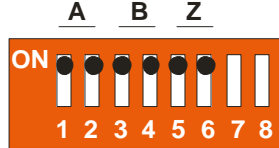

2.3.1. TTL encoders with differential outputs (suitable for signal levels up to 5.5 volts according to RS422 standard)

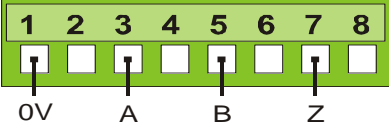
Terminal Connections	DIL Switch Setting
 <p>0V A /A B /B Z /Z</p>	 <p>A B Z</p> <p>ON</p> <p>1 2 3 4 5 6 7 8</p>
The common 0V terminal may be optionally connected or remain unconnected	

2.3.2. Encoders with single-ended outputs, without inverted signals (suitable for HTL levels >15 volts only)

Terminal Connections	DIL Switch Setting
 <p>0V A B Z</p>	 <p>ON</p> <p>1 2 3 4 5 6 7 8</p>
It is mandatory to connect the common 0V terminal	

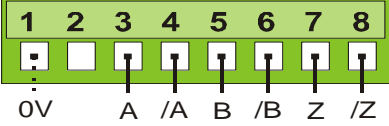
2.3.3. HTL encoders with differential outputs (suitable for signal levels from 10 to 30 volts)

Terminal Connections	DIL Switch Setting
 <p>0V A /A B /B Z /Z</p>	 <p>ON</p> <p>1 2 3 4 5 6 7 8</p>
The common 0V terminal may be optionally connected or remain unconnected	

2.3.4. Differential signals for encoder channels A, /A, B, /B but single-ended marker pulse from proximity switch or photocell

Besides the most common standard configurations shown before, the unit allows setting of any other input configuration. The block diagram shows which of the DIL switch positions is responsible for each of the channels. It is easy to figure out other settings from the examples given in this manual.

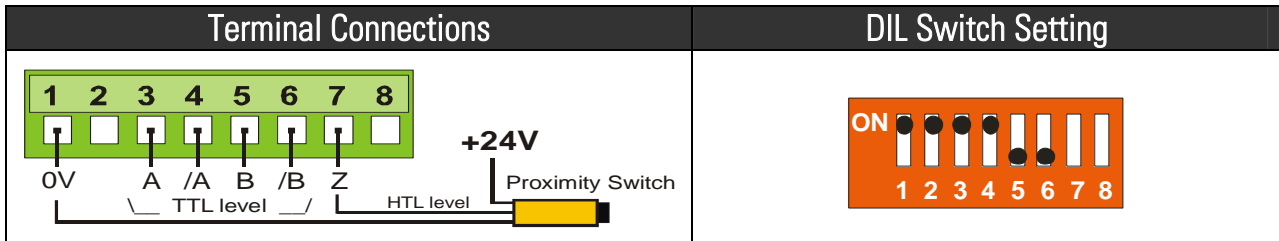



- The normal encoder input terminal will not accept any single-ended signals with TTL level, i.e. single-ended signals have to provide HTL level
- Nevertheless, in special cases, the cascading inputs of the unit can be used to apply single-ended TTL signals (CMOS input, Low <0.8 V, High >3.5 V). This however assumes proper EMC conditions and environment as well as short cables on the input side.
- The input terminal strip provides a codification to avoid accidental mix-up with the other connectors of the unit

2.4. The Outputs

All outputs always provide the non-inverted and the inverted signals, even when on the input side the inverted signals are not available.

If terminal "Level" of an output is unconnected, the corresponding output level will automatically be TTL (approx. 5 volts).

Applying any external voltage >5.5 volts between terminal 1 (0V) and terminal 2 (+Lev.) will increase the output level correspondingly (permitted range 5.5 ... 30 volts).

Each of the outputs can be connected to an individual external voltage, thus providing individual output swing on each of the output channels.

Output lines are short-circuit-proof and the maximum output current is 30 mA per line.

The terminal assignment can be found in the block diagram and is also printed to the front plate of the unit. All output terminal strips have the same codification, since it is fully unimportant to which of the outputs a terminal strip is connected (only the external voltage applied to the "Lev." input of the mating connector is responsible for the output level).

2.5. Cascading of Several Units and Encoder Select Function

The unit can be cascaded very easily to any number of output channels, without loss of regular encoder outputs. For cascading, pins 1, 3, 5 and 7 of the cascading output of the first unit must be connected to the corresponding pins of the cascading input of the follower unit.

An appropriate ribbon cable connection is available under motrona part # FK470

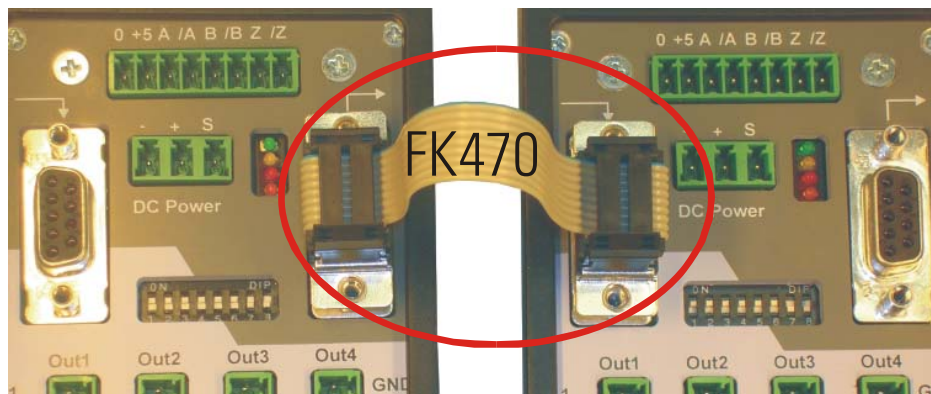

Cascaded units allow selection of the active source encoder via the encoder select input on the 3-position power connector (see also block diagram):

LOW (or open): outputs refer to the encoder input of the same unit

HIGH (10 – 30 volts): outputs refer to the encoder input of the preceding unit

It is possible at any time to switch over from one to the other source encoder during operation.



Where only one common encoder is used, the select input of the first unit remains unconnected. The select inputs of all follower units are advantageously connected to the +pole of the power supply located next to the select input

3. Technical Specifications

Power supply	:	10 – 30 VDC
Power consumption: (without encoder supply)	:	approx. 100 mA
Aux. encoder supply	:	built-in 5.5 volts, 200 mA *)
Max. frequency	:	TTL differential and RS422: 500 kHz (diff. voltage >0,5V) HTL differential and single-ended: 200 kHz
Input level with HTL single-ended (no inverted signal available)	:	Low: < 10 V, High: > 15 V
Input level with HTL differential (inverted signal available)	:	10 - 30 V (diff. voltage >9 V)
Input level "Select" Input	:	Low: < 4 V, High: > 10 V
Cascading input	:	A, B, Z, CMOS Level 5 V (Low <0.8 V, High >3.5 V)
Outputs	:	Push-pull stages 5 – 30 V / 30 mA (short-circuit-proof)
Propagation delay time	:	600 nsec.
Mounting	:	Standard DIN rail
Weight	:	approx. 400 g
Temperature range	:	Operation: 0 – 50 °C (+32 - +122 °F) Storage: -25 - +75° (-13 - +167°F)
Conformity and standards	:	EMC 2004/108/EC: EN 61000-6-2 EN 61000-6-3

*) Please observe galvanic connection to the power supply

4. Dimensions

