

## S50 SERIES

The **S50** series offers all optical functions within a M18 housing. With the universal sensing functions of proximity, polarised retroreflex and through beam, which are also available with class 1 laser emission, as well as the more advanced functions of background suppression, contrast and luminescence, the S50 really is one housing for all applications. The S50 setting is carried out by either by potentiometer, which is sealed to IP67, or using the patented EASYtouch™ push-button teach system, which gives rapid and precise automatic setting of the switching points. The S50 series is available both in flat plastic format ideal for M18 nut or screw mounting through the sensor body, as well as a cylindrical metal housing. Axial or radial optics are available in both housings with integral cable or M12 connection conforming to EN 60947-5-2, the European wiring standard. The performance, versatility and extensive optical sensing options, positions the S50 series as the new bench mark for customers focused on the evolution of technology and development of standards.

**CONNECTRIC SYSTEMS INC.**  
 28-207 Edgeley Blvd., Concord, Ontario, L4K 4B5  
 Ph: 905-669-0080 Fax: 905-669-0082  
 www.connectric.com info@connectric.com

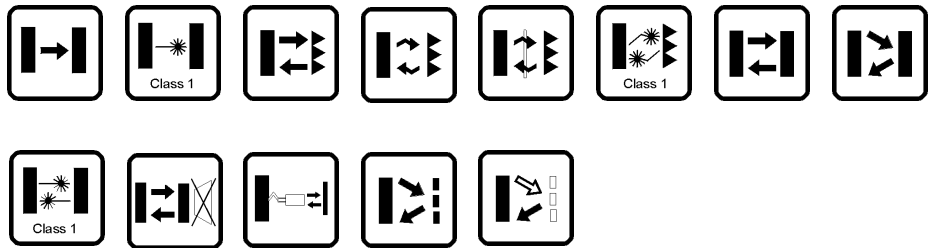

## HIGHLIGHTS

- Complete range of optic functions, universal, application and laser class 1
- Flat plastic tubular housing for improved versatility or metal cylindrical housing
- Versions with axial or radial optics, with fixed, trimmer or EASYtouch™ teach-in adjustment
- Cable or M12 connection with EN standard NPN or PNP NO-NC configuration

## APPLICATIONS

**Ceramics**

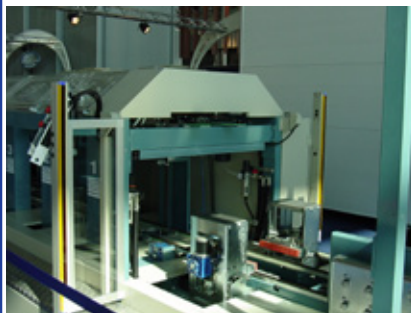

**Transportation lines**



**Beverage & Bottling**



**Packaging lines**



## G/F INFRARED EMISSION

Longer operating distances can be obtained utilising separate emitter and receiver units. The infrared emission is modulated to avoid interference with other light sources and the emitter is fitted with test inputs for remote system interrogation.



## RADIAL OPTICS



## ACCESSORIES

For **dedicated accessories** refer to the **ACCESSORIES** section of this catalogue.

Refer also to **Connectors and Fixing brackets** of the **General Catalogue**.

## DIMENSIONS

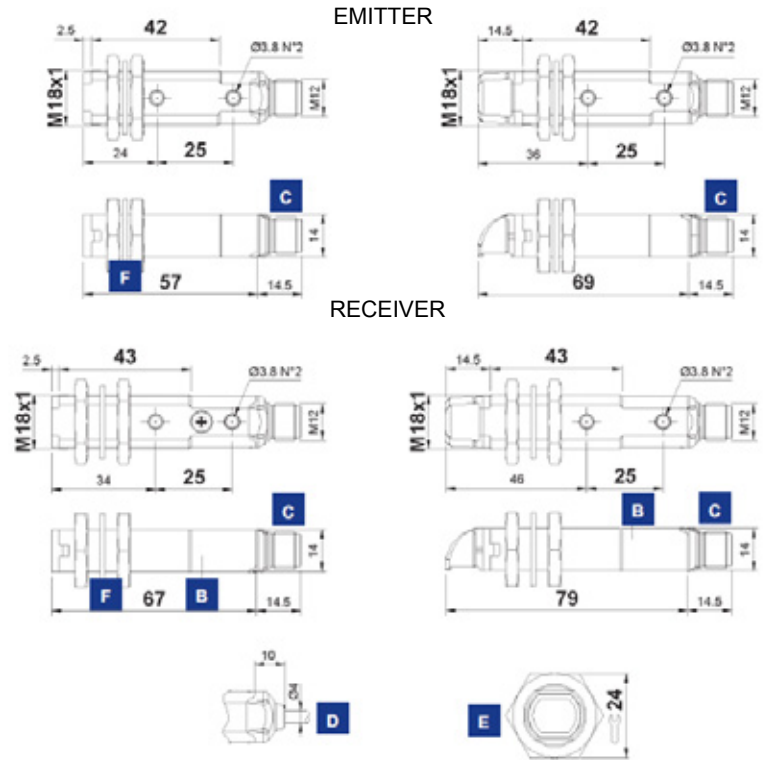

## INDICATORS AND SETTINGS



- A** OUTPUT status and stability LEDs (receiver); power on LED (emitter)
- B** Adjustment trimmer (receiver)
- C** M12 connector output
- D** Cable output
- E** Fixing nuts
- F** Fixing gasket

Single-turn trimmer for sensitivity adjustment. Rotate in a clockwise direction to increase the operating distance.

## CONNECTIONS



### EMITTER

#### S50-PA/PR-2

BROWN	1	+	10 ... 30 Vdc
WHITE	2		TEST +
BLACK	4		TEST -
BLUE	3	-	0 V

BROWN	1	+	10 ... 30 Vdc
WHITE	2		NC OUTPUT
BLACK	4		NO OUTPUT
BLUE	3	-	0 V



### RECEIVER

#### S50-PA/PR-5

TEST + (WHITE)	2	+	10 ... 30 Vdc (BROWN)
0 V - (BLUE)	3		
	1		
	4		TEST - (BLACK)

NC OUTPUT (WHITE)	2	+	10 ... 30 Vdc (BROWN)
0 V - (BLUE)	3		
	1		
	4		NO OUTPUT (BLACK)

Versions and options: refer to **MODEL ALPHABETICAL INDEX** of this catalogue.

**TECHNICAL DATA**

**TECHNICAL NOTES**

- <sup>1</sup>Limit values
- <sup>2</sup>Average life of 100.000 h with TA = +25 °C
- <sup>3</sup>270° single-turn trimmer
- <sup>4</sup>Emitter off with Test+ on Vdc and Test- on 0 V
- <sup>5</sup>PVC, 4 x 0.14 mm<sup>2</sup>
- <sup>6</sup>Compatible with quick connection systems
- <sup>7</sup>A - reverse polarity protection
- B - overload and short-circuit protection on receiver outputs

		S50-PA-2-F01-NN	S50-PA-2-F01-PP	S50-PA-2-G00-XG	S50-PR-2-F01-NN	S50-PR-2-F01-PP	S50-PR-2-G00-XG	S50-PA-5-F01-NN	S50-PA-5-F01-PP	S50-PA-5-G00-XG	S50-PR-5-F01-NN	S50-PR-5-F01-PP	S50-PR-5-G00-XG
<b>Operating distance:</b>													
axial optics	0 ... 30 m	•	•	•				•	•	•			
radial optics	0 ... 25 m				•	•	•				•	•	•
<b>Power supply:</b>	10 ... 30 Vdc <sup>1</sup>	•	•	•	•	•	•	•	•	•	•	•	•
<b>Ripple:</b>	≤ 2 Vpp	•	•	•	•	•	•	•	•	•	•	•	•
<b>Consumption:</b>													
emitter	≤ 35 mA			•			•			•			•
receiver	≤ 30 mA	•	•		•	•		•	•		•	•	
<b>Light emission:</b>	infrared LED 880 nm <sup>2</sup>			•			•			•			•
<b>Spot dimension:</b>													
axial optics	approx. 500 mm at 15 m			•						•			
radial optics	approx. 470 mm at 10 m						•						•
<b>Setting:</b>	sensitivity trimmer <sup>3</sup>	•	•		•	•		•	•		•	•	
<b>Indicators:</b>	yellow OUTPUT LED	•	•		•	•		•	•		•	•	
	green STABILITY LED	•	•		•	•		•	•		•	•	
	green POWER ON LED			•			•			•			•
<b>Output type:</b>	PNP, NO and NC		•				•			•			•
	NPN, NO and NC	•			•	•		•	•		•	•	
<b>Output current:</b>	≤ 100 mA	•	•		•	•		•	•		•	•	
<b>Saturation voltage:</b>	≤ 2 V	•	•		•	•		•	•		•	•	
<b>Response time:</b>	2 ms	•	•		•	•		•	•		•	•	
<b>Switching frequency:</b>	250 Hz	•	•		•	•		•	•		•	•	
<b>Operating mode:</b>	dark on NO / light on NC	•	•		•	•		•	•		•	•	
<b>Auxiliary functions:</b>	Test + and Test - <sup>4</sup>			•			•			•			•
<b>Connection:</b>	2 m Ø 4 mm cable <sup>5</sup>	•	•	•	•	•		•	•	•	•	•	•
	M12 4-pole connector <sup>6</sup>						•	•	•	•	•	•	•
<b>Electrical protection:</b>	class 2	•	•	•	•	•	•	•	•	•	•	•	•
<b>Mechanical protection:</b>	IP67	•	•	•	•	•	•	•	•	•	•	•	•
<b>Protection devices:</b>	A, B <sup>7</sup>	•	•	•	•	•	•	•	•	•	•	•	•
<b>Housing material:</b>	PBT	•	•	•	•	•	•	•	•	•	•	•	•
<b>Lens material:</b>	PMMA	•	•	•	•	•	•	•	•	•	•	•	•
<b>Weight:</b>	75 g max.	•	•	•	•	•	•	•	•	•	•	•	•
	25 g max.												
<b>Operating temperature:</b>	-25 ... +55°C	•	•	•	•	•	•	•	•	•	•	•	•
<b>Storage temperature:</b>	-25 ... +70°C	•	•	•	•	•	•	•	•	•	•	•	•
<b>Reference standard:</b>	EN 60947-5-2	•	•	•	•	•	•	•	•	•	•	•	•

**SELECTION TABLE**

receiver - axial optics - 2 m cable		
S50-PA-2-F01-NN	952001660	NPN
S50-PA-2-F01-PP	952001150	PNP
emitter - axial optics - 2 m cable		
S50-PA-2-G00-XG	952001190	
receiver - radial optics - 2 m cable		
S50-PR-2-F01-NN	952001820	NPN
S50-PR-2-F01-PP	952001170	PNP
emitter - radial optics - 2 m cable		
S50-PR-2-G00-XG	952001210	
receiver - axial optics - M12 connector		
S50-PA-5-F01-NN	952001550	NPN
S50-PA-5-F01-PP	952001160	PNP
emitter - axial optics - M12 connector		
S50-PA-5-G00-XG	952001200	
receiver - radial optics - M12 connector		
S50-PR-5-F01-NN	952001760	NPN
S50-PR-5-F01-PP	952001180	PNP
emitter - radial optics - M12 connector		
S50-PR-5-G00-XG	952001220	

All the ordering codes and information are summarised in the last pages of this catalogue.



\*Only on axial optic models

**DETECTION DIAGRAMS**

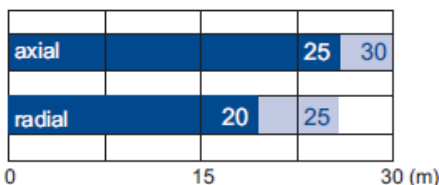

■ Recommended operating distance  
 ■ Maximum operating distance

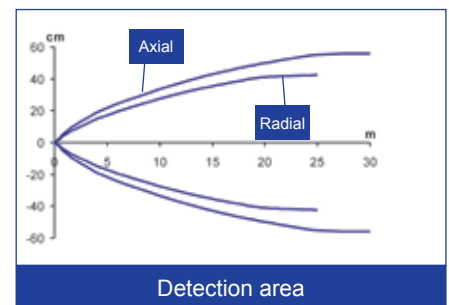
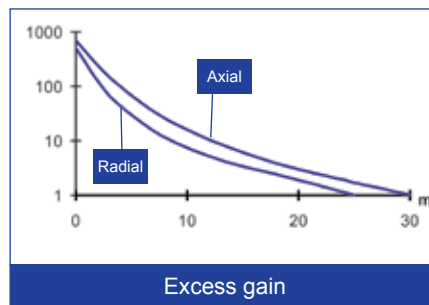

## G/F INFRARED EMISSION

Longer operating distances can be obtained utilising separate emitter and receiver units. The infrared emission is modulated to avoid interference with other light sources and the emitter is fitted with test inputs for remote system interrogation.



RADIAL OPTICS

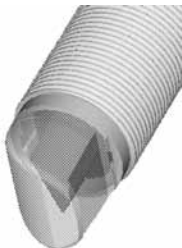

## DIMENSIONS

### EMITTER

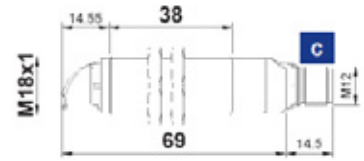
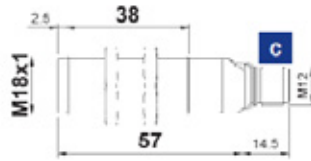

### RECEIVER

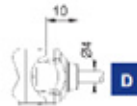
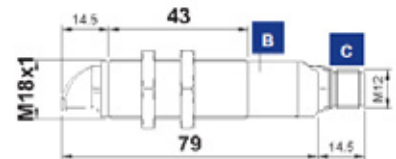
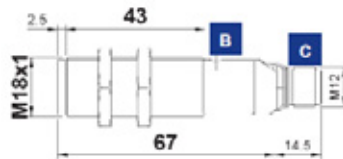

## INDICATORS AND SETTINGS

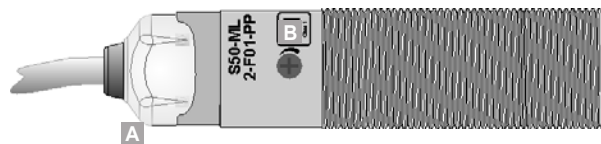

- A** OUTPUT status and stability LEDs (receiver); power on LED (emitter)
- B** Adjustment trimmer (receiver)
- C** M12 connector output
- D** Cable output
- E** Fixing nuts

Single-turn trimmer for sensitivity adjustment. Rotate in a clockwise direction to increase the operating distance.

## ACCESSORIES

For **dedicated accessories** refer to the **ACCESSORIES** section of this catalogue.

Refer also to **Connectors and Fixing brackets of the General Catalogue**.

## CONNECTIONS



### EMITTER

S50-MA/MR-2

BROWN	1	+	10 ... 30 Vdc
WHITE	2	TEST +	
BLACK	4	TEST -	
BLUE	3	-	0 V

BROWN	1	+	10 ... 30 Vdc
WHITE	2	NC OUTPUT	
BLACK	4	NO OUTPUT	
BLUE	3	-	0 V



### RECEIVER

S50-MA/MR-5

TEST + (WHITE)	2	+	10 ... 30 Vdc (BROWN)
0 V (BLUE)	3	-	
TEST - (BLACK)	4		

NC OUTPUT (WHITE)	2	+	10 ... 30 Vdc (BROWN)
0 V (BLUE)	3	-	
NO OUTPUT (BLACK)	4		

Versions and options: refer to **MODEL ALPHABETICAL INDEX** of this catalogue.

**TECHNICAL DATA**

TECHNICAL NOTES		S50-MA-2-F01-NN	S50-MA-2-F01-PP	S50-MA-2-G00-XG	S50-MR-2-F01-NN	S50-MR-2-F01-PP	S50-MR-2-G00-XG	S50-MA-5-F01-NN	S50-MA-5-F01-PP	S50-MA-5-G00-XG	S50-MR-5-F01-NN	S50-MR-5-F01-PP	S50-MR-5-G00-XG
<b>Operating distance:</b>													
axial optics	0 ... 20 m	•	•	•				•	•	•			
radial optics	0 ... 15 m				•	•	•				•	•	•
<b>Power supply:</b>	10 ... 30 Vdc <sup>1</sup>	•	•	•	•	•	•	•	•	•	•	•	•
<b>Ripple:</b>	≤ 2 Vpp	•	•	•	•	•	•	•	•	•	•	•	•
<b>Consumption:</b>													
emitter	≤ 35 mA			•			•			•			•
receiver	≤ 30 mA	•	•		•	•		•	•		•	•	
<b>Light emission:</b>	infrared LED 880 nm <sup>2</sup>			•			•			•			•
<b>Spot dimension:</b>													
axial optics	approx. 500 mm at 15 m			•						•			
radial optics	approx. 470 mm at 10 m						•						•
<b>Setting:</b>	sensitivity trimmer <sup>3</sup>	•	•		•	•		•	•		•	•	
<b>Indicators:</b>	yellow OUTPUT LED	•	•		•	•		•	•		•	•	
	green STABILITY LED	•	•		•	•		•	•		•	•	
	green POWER ON LED			•			•			•			•
<b>Output type:</b>	PNP, NO and NC		•		•		•		•		•		•
	NPN, NO and NC	•			•		•		•		•		•
<b>Output current:</b>	≤ 100 mA	•	•		•	•		•	•		•	•	
<b>Saturation voltage:</b>	≤ 2 V	•	•		•	•		•	•		•	•	
<b>Response time:</b>	2 ms	•	•		•	•		•	•		•	•	
<b>Switching frequency:</b>	250 Hz	•	•		•	•		•	•		•	•	
<b>Operating mode:</b>	dark on NO / light on NC	•	•		•	•		•	•		•	•	
<b>Auxiliary functions:</b>	Test + and Test - <sup>4</sup>			•			•			•			•
<b>Connection:</b>	2 m Ø 4 mm cable <sup>5</sup>	•	•		•	•		•	•		•	•	
	M12 4-pole connector <sup>6</sup>							•	•		•	•	
<b>Electrical protection:</b>	class 2	•	•	•	•	•	•	•	•	•	•	•	•
<b>Mechanical protection:</b>	IP67	•	•	•	•	•	•	•	•	•	•	•	•
<b>Protection devices:</b>	A, B <sup>7</sup>	•	•	•	•	•	•	•	•	•	•	•	•
<b>Housing material:</b>	nickel plated brass	•	•	•	•	•	•	•	•	•	•	•	•
<b>Lens material:</b>	PMMA	•	•	•	•	•	•	•	•	•	•	•	•
<b>Weight:</b>	110 g max.	•	•	•	•	•	•						
	60 g max.							•	•	•	•	•	•
<b>Operating temperature:</b>	-25 ... +55°C	•	•	•	•	•	•	•	•	•	•	•	•
<b>Storage temperature:</b>	-25 ... +70°C	•	•	•	•	•	•	•	•	•	•	•	•
<b>Reference standard:</b>	EN 60947-5-2	•	•	•	•	•	•	•	•	•	•	•	•

<sup>1</sup>Limit values  
<sup>2</sup>Average life of 100.000 h with TA = +25 °C  
<sup>3</sup>270° single-turn trimmer  
<sup>4</sup>Emitter off with Test+ on Vdc and Test- on 0 V  
<sup>5</sup>PVC, 4 x 0.14 mm<sup>2</sup>  
<sup>6</sup>Compatible with quick connection systems  
<sup>7</sup>A - reverse polarity protection  
 B - overload and short-circuit protection on receiver outputs

**SELECTION TABLE**

receiver - axial optics - 2 m cable		
S50-MA-2-F01-NN	952021700	NPN
S50-MA-2-F01-PP	952021250	PNP

emitter - axial optics - 2 m cable		
S50-MA-2-G00-XG	952021060	

receiver - radial optics - 2 m cable		
S50-MR-2-F01-NN	952021640	NPN
S50-MR-2-F01-PP	952021170	PNP

emitter - radial optics - 2 m cable		
S50-MR-2-G00-XG	952021180	

receiver - axial optics - M12 connector		
S50-MA-5-F01-NN	952021700	NPN
S50-MA-5-F01-PP	952021250	PNP

emitter - axial optics - M12 connector		
S50-MA-5-G00-XG	952021260	

receiver - radial optics - M12 connector		
S50-MR-5-F01-NN	952021800	NPN
S50-MR-5-F01-PP	952021370	PNP

emitter - radial optics - M12 connector		
S50-MR-5-G00-XG	952021380	

All the ordering codes and information are summarised in the last pages of this catalogue.



\*Only on axial optic models

**DETECTION DIAGRAMS**

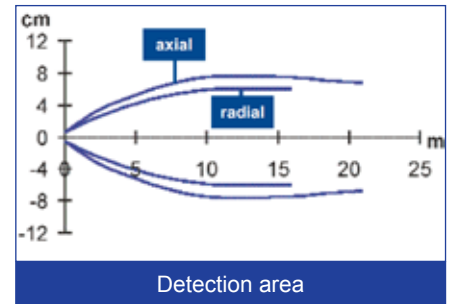
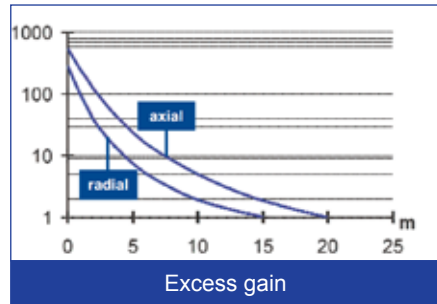
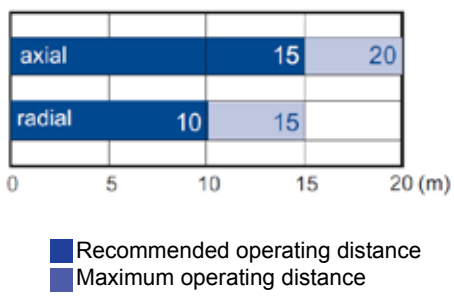

## G/F LASER RED EMISSION

The high operating distance typical of emitter and receiver pairs is notably increased thanks to the use of visible red laser emission. The laser beam can be easily aligned and offers excellent detection resolution of even small objects. The class 1 laser emission guarantees maximum safety for the operators in all applications.



RADIAL OPTICS



## ACCESSORIES

For **dedicated accessories** refer to the **ACCESSORIES** section of this catalogue.

Refer also to **Connectors and Fixing brackets of the General Catalogue.**

## DIMENSIONS

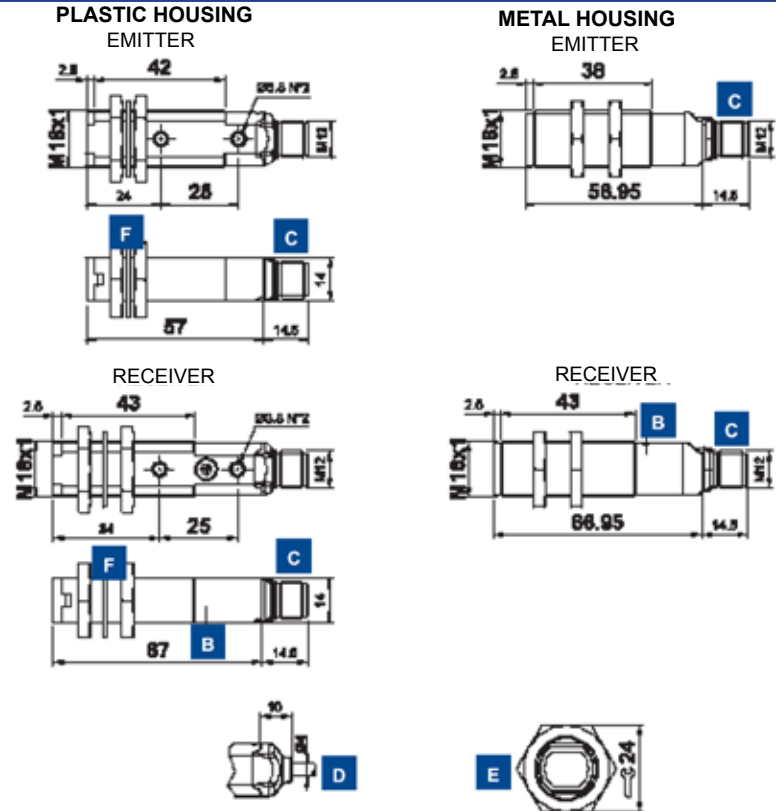

## INDICATORS AND SETTINGS



- A** OUTPUT status and stability LEDs (receiver); power on LED (emitter)
- B** Adjustment trimmer (receiver)
- C** M12 connector output
- D** Cable output
- E** Fixing nuts
- F** Fixing gasket

Single-turn trimmer for sensitivity adjustment. Rotate in a clockwise direction to increase the operating distance. Decrease sensitivity to increase resolution.

## CONNECTIONS



EMITTER

S50-PL/PH-2

BROWN	1	+	10 ... 30 Vdc
WHITE	2	TEST +	
BLACK	4	NOT USED	
BLUE	3	0 V	

  

BROWN	1	+	10 ... 30 Vdc
WHITE	2	NC OUTPUT	
BLACK	4	NO OUTPUT	
BLUE	3	0 V	



RECEIVER

S50-PL/PH-5

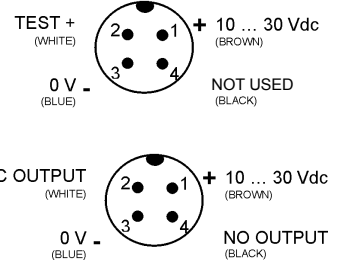

Versions and options: refer to **MODEL ALPHABETICAL INDEX** of this catalogue.

**TECHNICAL DATA**

**TECHNICAL NOTES**

- <sup>1</sup>Limit values
- <sup>2</sup>Average life of 100.000 h with T<sub>A</sub> = +25 °C
- <sup>3</sup>270° single-turn trimmer
- <sup>4</sup>Emitter off with Test+ connected to +Vcc; Emitter on with Test+ not connected or connected to 0V
- <sup>5</sup>PVC, 4 x 0.14 mm<sup>2</sup>
- <sup>6</sup>Compatible with quick connection systems
- <sup>7</sup>A - reverse polarity protection  
B - overload and short-circuit protection on receiver outputs

		S50-PL-2-G00-XG	S50-PL-2-F01-NN	S50-PL-2-F01-PP	S50-PL-5-G00-XG	S50-PL-5-F01-NN	S50-PL-5-F01-PP	S50-PH-2-G00-XG	S50-PH-2-F01-NN	S50-PH-2-F01-PP	S50-PH-5-G00-XG	S50-PH-5-F01-NN	S50-PH-5-F01-PP
<b>Operating distance:</b>													
axial optics	0 ... 60 m	•	•	•	•	•	•	•	•	•	•	•	•
radial optics	0 ... 50 m						•	•	•	•	•	•	•
<b>Power supply:</b>	10 ... 30 Vdc <sup>1</sup>	•	•	•	•	•	•	•	•	•	•	•	•
<b>Ripple:</b>	≤ 2 Vpp	•	•	•	•	•	•	•	•	•	•	•	•
<b>Consumption:</b>													
emitter	≤ 35 mA	•			•		•		•		•		•
receiver	≤ 30 mA		•	•		•		•	•	•		•	•
<b>Light emission:</b>	red Laser 650 nm <sup>2</sup>	•			•		•		•		•		•
	class 1 EN 60825-1												
	class II CDRH21 CFR .104010												
<b>Resolution:</b>	approx. 2.5 mm at 5 m		•	•		•		•	•	•		•	•
	approx. 5 mm at 10 m		•	•		•		•	•	•		•	•
	approx. 10 mm over 20 m		•	•		•		•	•	•		•	•
<b>Setting:</b>	sensitivity trimmer <sup>3</sup>		•	•		•		•	•	•		•	•
<b>Indicators:</b>	yellow OUTPUT LED		•	•		•		•	•	•		•	•
	green POWER ON LED	•	•	•	•	•	•	•	•	•	•	•	•
<b>Output type:</b>	PNP, NO and NC			•					•				•
	NPN, NO and NC		•		•		•		•		•		•
<b>Output current:</b>	≤ 100 mA		•	•		•		•	•	•		•	•
<b>Saturation voltage:</b>	≤ 2 V		•	•		•		•	•	•		•	•
<b>Response time:</b>	333 μs		•	•		•		•	•	•		•	•
<b>Switching frequency:</b>	1.5 kHz		•	•		•		•	•	•		•	•
<b>Operating mode:</b>	dark on NO / light on NC		•	•		•		•	•	•		•	•
<b>Auxiliary functions:</b>	Test + <sup>4</sup>	•			•		•		•		•		•
<b>Connection:</b>	2 m Ø 4 mm cable <sup>5</sup>	•	•	•		•		•	•	•		•	•
	M12 4-pole connector <sup>6</sup>				•	•	•		•	•	•	•	•
<b>Electrical protection:</b>	class 2	•	•	•	•	•	•	•	•	•	•	•	•
<b>Mechanical protection:</b>	IP67	•	•	•	•	•	•	•	•	•	•	•	•
<b>Protection devices:</b>	A, B <sup>7</sup>	•	•	•	•	•	•	•	•	•	•	•	•
<b>Housing material:</b>	PBT	•	•	•	•	•	•	•	•	•	•	•	•
	Nickel plated brass						•	•	•	•	•	•	•
<b>Lens material:</b>	PMMA / glass	•	•	•	•	•	•	•	•	•	•	•	•
<b>Weight:</b>	75 g max.	•	•	•			•	•	•	•		•	•
	25 g max.				•	•	•	•	•	•	•	•	•
<b>Operating temperature:</b>	-10 ... +50 °C	•	•	•	•	•	•	•	•	•	•	•	•
<b>Storage temperature:</b>	-25 ... +70 °C	•	•	•	•	•	•	•	•	•	•	•	•
<b>Reference standard:</b>	EN 60947-5-2,	•	•	•	•	•	•	•	•	•	•	•	•
	EN 60825-1, CDRH21 CFR 1040.10	•			•		•		•		•		•

**SELECTION TABLE**

emitter - axial optics - 2 m cable

S50-PL-2-G00-XG	952001420	
-----------------	-----------	--

receiver - axial optics - 2 m cable

S50-PL-2-F01-NN	952021890	NPN
S50-PL-2-F01-PP	952021400	PNP

emitter - radial optics - 2 m cable

S50-ML-2-G00-XG	952002060	
-----------------	-----------	--

receiver - axial optics - 2 m cable

S50-ML-2-F01-NN	952002030	NPN
S50-ML-2-F01-PP	952002020	PNP

emitter -axial optics - M12 connector

S50-PL-5-G00-XG	952001430	
-----------------	-----------	--

receiver - axial optics - M12 connector

S50-PL-5-F01-NN	952001860	NPN
S50-PL-5-F01-PP	952001410	PNP

emitter - radial optics - M12 connector

S50-ML-5-G00-XG	952022070	
-----------------	-----------	--

receiver - axial optics - M12 connector

S50-ML-5-F01-NN	952002050	NPN
S50-ML-5-F01-PP	952002040	PNP

All the ordering codes and information are summarised in the last pages of this catalogue.

**The use of the MICRO-18 fixing bracket (cod. 95ACC1380) is recommended for the correct optic axis alignment of the laser emission.**



\*Only on axial optic models

**DETECTION DIAGRAMS**



■ Operating distance

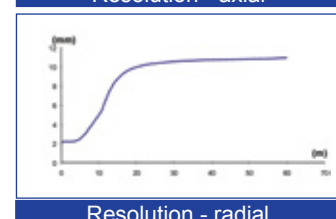
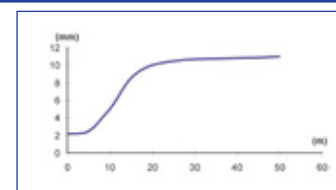
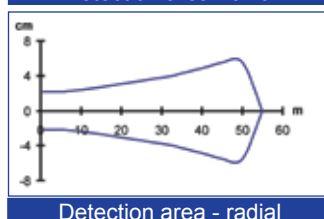
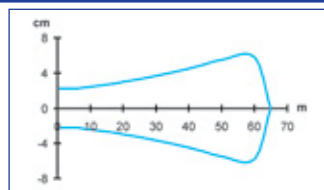

## G/F LASER RED EMISSION

The high operating distance typical of emitter and receiver pairs is notably increased thanks to the use of visible red laser emission. The laser beam can be easily aligned and offers excellent detection resolution of even small objects. The class 1 laser emission guarantees maximum safety for the operators in all applications.



RADIAL OPTICS

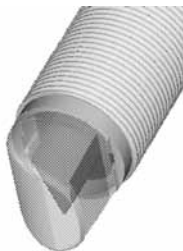

## DIMENSIONS

EMITTER

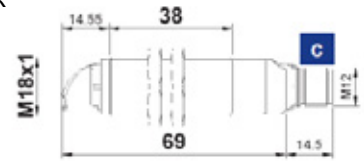
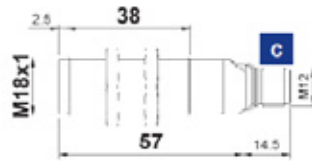

RECEIVER

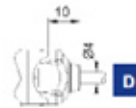
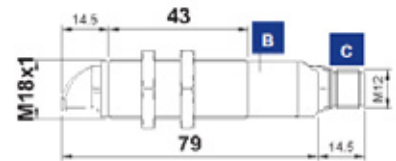
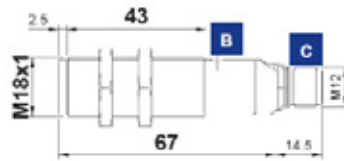

## INDICATORS AND SETTINGS

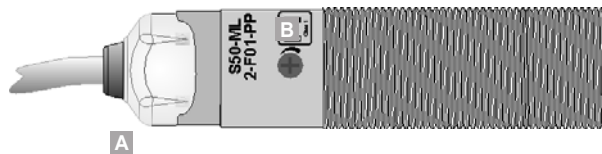

- A** OUTPUT status and power on LED
- B** Adjustment trimmer (receiver)
- C** M12 connector output
- D** Cable output
- E** Fixing nuts
- F** Fixing gasket

Single-turn trimmer for sensitivity adjustment. Rotate in a clockwise direction to increase the operating distance. Decrease sensitivity to increase resolution.

## ACCESSORIES

For dedicated accessories refer to the **ACCESSORIES** section of this catalogue.

Refer also to **Connectors and Fixing brackets of the General Catalogue**.

## CONNECTIONS

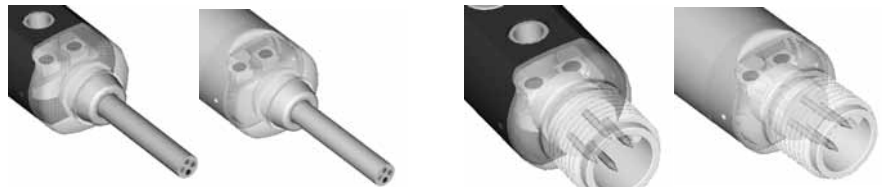

S50-ML/MH-2

BROWN	1	+	10 ... 30 Vdc
WHITE	2	TEST +	
BLACK	4	NOT USED	
BLUE	3	-	0 V

BROWN	1	+	10 ... 30 Vdc
WHITE	2	NC OUTPUT	
BLACK	4	NO OUTPUT	
BLUE	3	-	0 V

EMITTER

S50-ML/MH-5

TEST + (WHITE)	2	+	10 ... 30 Vdc (BROWN)
0 V - (BLUE)	3		NOT USED (BLACK)

RECEIVER

NC OUTPUT (WHITE)	2	+	10 ... 30 Vdc (BROWN)
0 V - (BLUE)	3		NO OUTPUT (BLACK)

Versions and options: refer to **MODEL ALPHABETICAL INDEX** of this catalogue.



**TECHNICAL DATA**

**TECHNICAL NOTES**

- <sup>1</sup>Limit values
- <sup>2</sup>Average life of 50.000 h with T<sub>A</sub> = +25 °C
- <sup>3</sup>270° single-turn trimmer
- <sup>4</sup>Emitter off with Test+ connected to +Vcc; Emitter on with Test+ not connected or connected to 0V
- <sup>5</sup>PVC, 4 x 0.14 mm<sup>2</sup>
- <sup>6</sup>Compatible with quick connection systems
- <sup>7</sup>A - reverse polarity protection  
B - overload and short-circuit protection on receiver outputs

		S50-ML-2-G00-XG	S50-ML-2-F01-NN	S50-ML-2-F01-PP	S50-ML-5-G00-XG	S50-ML-5-F01-NN	S50-ML-5-F01-PP	S50-MH-2-G00-XG	S50-MH-2-F01-NN	S50-MH-2-F01-PP	S50-MH-5-G00-XG	S50-MH-5-F01-NN	S50-MH-5-F01-PP
<b>Operating distance:</b>													
axial optics	0 ... 60 m	•	•	•	•	•	•	•	•	•	•	•	•
radial optics	0 ... 50 m						•	•	•	•	•	•	•
<b>Power supply:</b>	10 ... 30 Vdc <sup>1</sup>	•	•	•	•	•	•	•	•	•	•	•	•
<b>Ripple:</b>	≤ 2 Vpp	•	•	•	•	•	•	•	•	•	•	•	•
<b>Consumption:</b>													
emitter	≤ 35 mA	•			•		•		•		•		•
receiver	≤ 30 mA		•	•		•		•	•			•	•
<b>Light emission:</b>	red Laser 650 nm <sup>2</sup>	•			•		•		•		•		•
	class 1 EN 60825-1												
	class II CDRH21 CFR .1040.10												
<b>Resolution:</b>	approx. 2.5 mm at 5 m		•	•		•		•	•		•		•
	approx. 5 mm at 10 m		•	•		•		•	•		•		•
	approx. 10 mm over 20 m		•	•		•		•	•		•		•
<b>Setting:</b>	sensitivity trimmer <sup>3</sup>		•	•		•		•	•		•		•
<b>Indicators:</b>	yellow OUTPUT LED		•	•		•		•	•		•		•
	green POWER ON LED	•	•	•	•	•	•	•	•	•	•	•	•
<b>Output type:</b>	PNP, NO and NC			•		•		•		•		•	•
	NPN, NO and NC	•			•		•		•		•		•
<b>Output current:</b>	≤ 100 mA		•	•		•		•	•		•		•
<b>Saturation voltage:</b>	≤ 2 V		•	•		•		•	•		•		•
<b>Response time:</b>	333 μs		•	•		•		•	•		•		•
<b>Switching frequency:</b>	1.5 kHz		•	•		•		•	•		•		•
<b>Operating mode:</b>	dark on NO / light on NC		•	•		•		•	•		•		•
<b>Auxiliary functions:</b>	Test + <sup>4</sup>	•			•		•		•		•		•
<b>Connection:</b>	2 m Ø 4 mm cable <sup>5</sup>	•	•	•			•	•	•				
	M12 4-pole connector <sup>6</sup>				•	•	•		•	•	•	•	•
<b>Electrical protection:</b>	class 2	•	•	•	•	•	•	•	•	•	•	•	•
<b>Mechanical protection:</b>	IP67	•	•	•	•	•	•	•	•	•	•	•	•
<b>Protection devices:</b>	A, B <sup>7</sup>	•	•	•	•	•	•	•	•	•	•	•	•
<b>Housing material:</b>	Nichel plated brass	•	•	•	•	•	•	•	•	•	•	•	•
<b>Lens material:</b>	PMMA / glass	•	•	•	•	•	•	•	•	•	•	•	•
<b>Weight:</b>	75 g max.	•	•	•			•	•	•		•	•	•
	25 g max.				•	•		•	•		•	•	•
<b>Operating temperature:</b>	-10 ... +50°C	•	•	•	•	•	•	•	•	•	•	•	•
<b>Storage temperature:</b>	-25 ... +70°C	•	•	•	•	•	•	•	•	•	•	•	•
<b>Reference standard:</b>	EN 60947-5-2,	•	•	•	•	•	•	•	•	•	•	•	•
	EN 60825-1, CDRH21 CFR 1040.10	•		•			•		•		•		•

**SELECTION TABLE**

emitter - axial optics - 2 m cable		
S50-ML-2-G00-XG	952021430	

receiver - axial optics - 2 m cable		
S50-ML-2-F01-NN	952021840	NPN
S50-ML-2-F01-PP	952021420	PNP

emitter - radial optics - 2 m cable		
S50-MH-2-G00-XG	952022060	

receiver - radial optics - 2 m cable		
S50-MH-2-F01-NN	952022030	NPN
S50-MH-2-F01-PP	952022020	PNP

emitter - axial optics - M12 connector		
S50-ML-5-G00-XG	952021470	

receiver - axial optics - M12 connector		
S50-ML-5-F01-NN	952021870	NPN
S50-ML-5-F01-PP	952021460	PNP

emitter - radial optics - M12 connector		
S50-MH-5-G00-XG	952022070	

receiver - radial optics - M12 connector		
S50-MH-5-F01-NN	952022050	NPN
S50-MH-5-F01-PP	952022040	PNP

All the ordering codes and information are summarised in the last pages of this catalogue.

**The use of the MICRO-18 fixing bracket (cod. 95ACC1380) is recommended for the correct optic axis alignment of the laser emission.**



\*Only on axial optic models

**DETECTION DIAGRAMS**



■ Operating distance

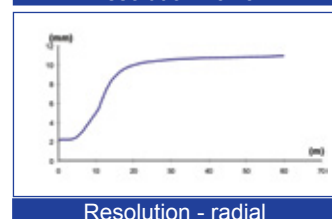
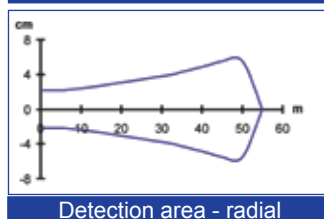
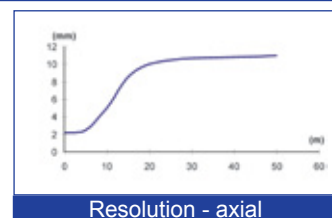
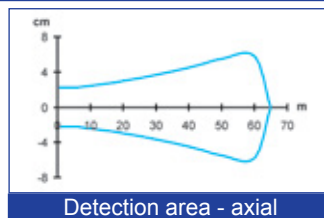

## A INFRARED EMISSION

With retroreflex sensors the object is detected when it interrupts the light beam generated between the sensor and its associated prismatic reflector. This retroreflex system, created between the sensor and the reflector, offers the advantage of electrically connecting one single unit instead of two, as in the emitter-receiver system.



## DIMENSIONS

### PLASTIC HOUSING

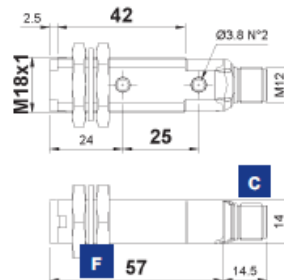

### METAL HOUSING

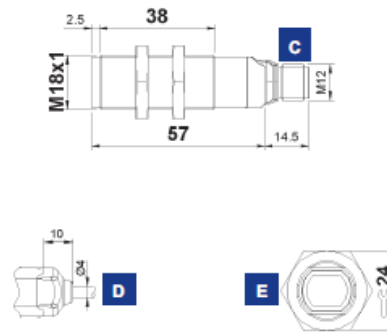

## INDICATORS AND SETTINGS

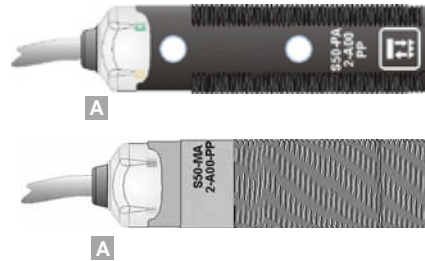

- A** OUTPUT status LED
- C** M12 connector output
- D** Cable output
- E** Fixing nuts
- F** Fixing gasket

## ACCESSORIES

For **dedicated accessories** refer to the **ACCESSORIES** section of this catalogue.

Refer also to **Connectors and Fixing brackets of the General Catalogue**.

## CONNECTIONS

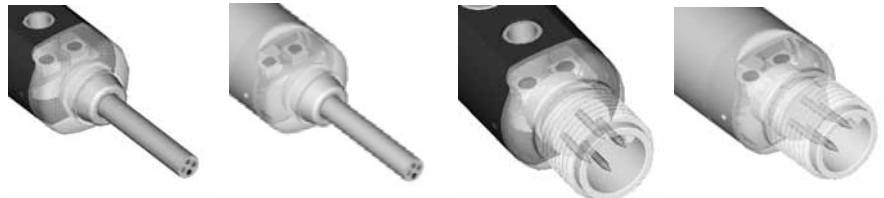

### S50-XX-2

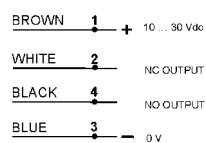

### S50-XX-5

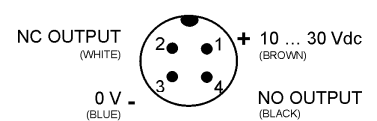

Versions and options: refer to **MODEL ALPHABETICAL INDEX** of this catalogue.

**TECHNICAL DATA**

**TECHNICAL NOTES**

- <sup>1</sup>Limit values
- <sup>2</sup>Average life of 100,000 h with TA = +25 °C
- <sup>3</sup>PVC, 4 x 0.14 mm<sup>2</sup>
- <sup>4</sup>Compatible with quick connection systems
- <sup>5</sup>A - reverse polarity protection
- B - overload and short-circuit protection on receiver outputs

		S50-PA-2-A00-NN	S50-PA-2-A00-PP	S50-PA-5-A00-NN	S50-PA-5-A00-PP	S50-MA-2-A00-NN	S50-MA-2-A00-PP	S50-MA-5-A00-NN	S50-MA-5-A00-PP
<b>Operating distance:</b>	0.1 ... 5 m	•	•	•	•	•	•	•	•
<b>Power supply:</b>	10 ... 30 Vdc <sup>1</sup>	•	•	•	•	•	•	•	•
<b>Ripple:</b>	≤ 2 Vpp	•	•	•	•	•	•	•	•
<b>Consumption:</b>	≤ 35 mA	•	•	•	•	•	•	•	•
<b>Light emission:</b>	infrared LED 880 nm <sup>2</sup>	•	•	•	•	•	•	•	•
<b>Spot dimension:</b>	approx. 100 mm at 2 m	•	•	•	•	•	•	•	•
<b>Indicators:</b>	yellow OUTPUT LED	•	•	•	•	•	•	•	•
<b>Output type:</b>	PNP, NO and NC	•	•	•	•	•	•	•	•
	NPN, NO and NC	•	•	•	•	•	•	•	•
<b>Output current:</b>	≤100 mA	•	•	•	•	•	•	•	•
<b>Saturation voltage:</b>	≤2 V	•	•	•	•	•	•	•	•
<b>Response time:</b>	0.5 ms	•	•	•	•	•	•	•	•
<b>Switching frequency:</b>	1 kHz	•	•	•	•	•	•	•	•
<b>Operating mode:</b>	dark on NO / light on NC	•	•	•	•	•	•	•	•
<b>Connection:</b>	2 m Ø 4 mm cable <sup>3</sup>	•	•			•	•		
	M12 4-pole connector <sup>4</sup>			•	•			•	•
<b>Electrical protection:</b>	class 2	•	•	•	•	•	•	•	•
<b>Mechanical protection:</b>	IP67	•	•	•	•	•	•	•	•
<b>Protection devices:</b>	A, B <sup>5</sup>	•	•	•	•	•	•	•	•
<b>Housing material:</b>	PBT	•	•	•	•				
	nickel plated brass					•	•	•	•
<b>Lens material:</b>	PMMA	•	•	•	•	•	•	•	•
<b>Weight:</b>	75 g max.	•	•						
	25 g max.			•	•				
	110 g max.					•	•		
	60 g max.							•	•
<b>Operating temperature:</b>	-25 ... +55°C	•	•	•	•	•	•	•	•
<b>Storage temperature:</b>	-25 ... +70°C	•	•	•	•	•	•	•	•
<b>Reference standard:</b>	EN 60947-5-2	•	•	•	•	•	•	•	•

**SELECTION TABLE**

plastic - axial optics - 2 m cable		
S50-PA-2-A00-NN	952002090	NPN
S50-PA-2-A00-PP	952002080	PNP

metal - axial optics - 2 m cable		
S50-MA-2-A00-NN	952022090	NPN
S50-MA-2-A00-PP	952022080	PNP

plastic - axial optics - M12 connector		
S50-PA-5-A00-NN	952002110	NPN
S50-PA-5-A00-PP	952002100	PNP

metal - axial optics - M12 connector		
S50-MA-5-A00-NN	952022110	NPN
S50-MA-5-A00-PP	952022100	PNP

All the ordering codes and information are summarised in the last pages of this catalogue.



**DETECTION DIAGRAMS**

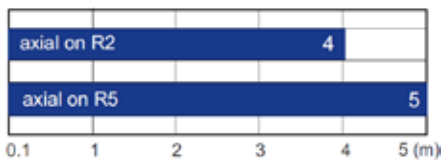

■ Operating distance

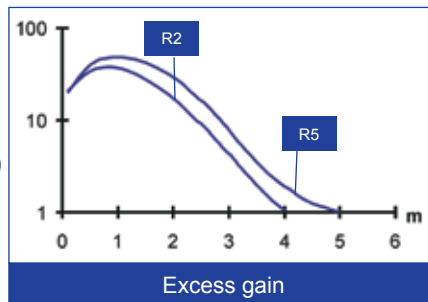

Excess gain

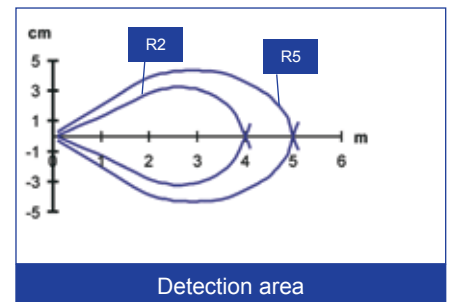

Detection area

## B INFRARED EMISSION

With retroreflex sensors the object is detected when it interrupts the light beam generated between the sensor and its associated prismatic reflector. Highpolarisation optic filters also allow reliable detection of very reflective objects, such as mirrored surfaces that, differently from the prismatic reflector, reflect the light beam without rotating the polarisation plane.



### RADIAL OPTICS

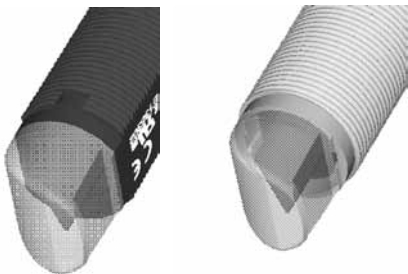

## ACCESSORIES

For **dedicated accessories** refer to the **ACCESSORIES** section of this catalogue.

Refer also to **Reflectors (A.01)**, **Connectors (A.03)** and **Fixing brackets (A.04)** of the General Catalogue.

## DIMENSIONS

### PLASTIC HOUSING

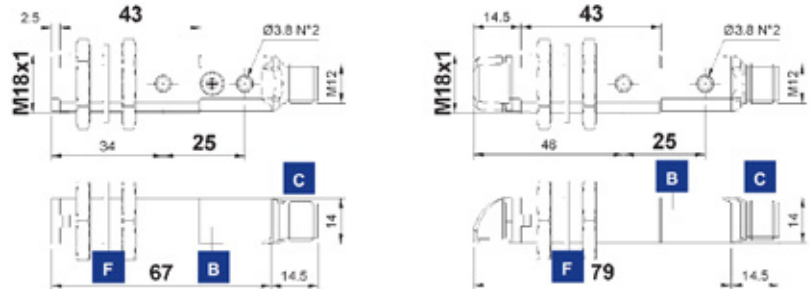

### METAL HOUSING

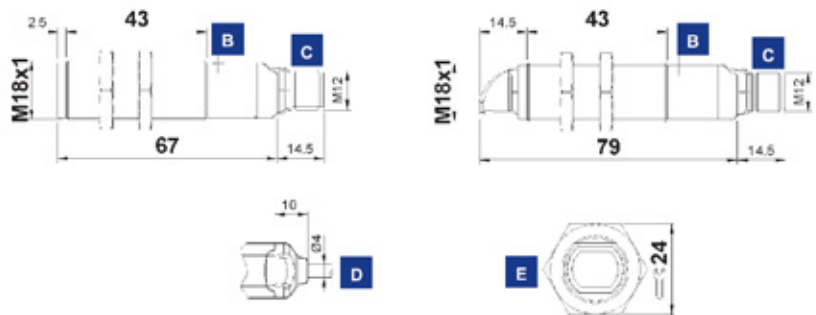

mm

## INDICATORS AND SETTINGS

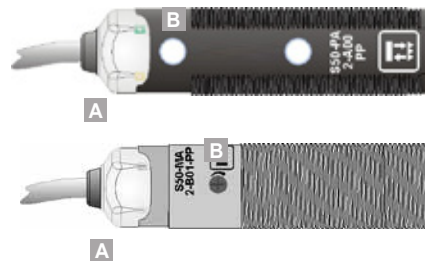

- A** OUTPUT status and stability LEDs
- B** Adjustment trimmer
- C** M12 connector output
- D** Cable output
- E** Fixing nuts
- F** Fixing gasket

Single-turn trimmer for sensitivity adjustment. Rotate in a clockwise direction to increase the operating distance.

## CONNECTIONS

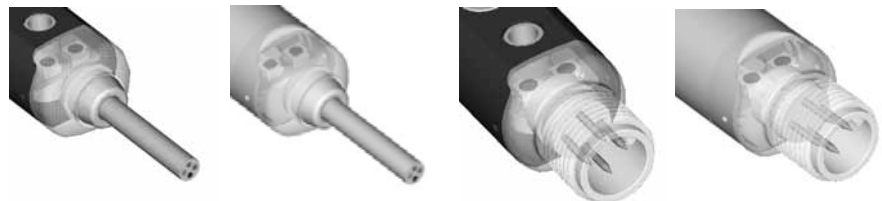

S50-XX-2

S50-XX-5

BROWN	1	+	10 ... 30 Vdc
WHITE	2		NC OUTPUT
BLACK	4		NO OUTPUT
BLUE	3	-	0 V

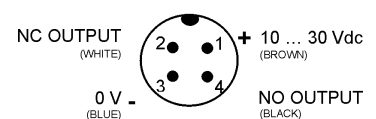

Versions and options: refer to **MODEL ALPHABETICAL INDEX** of this catalogue.

**TECHNICAL DATA**

**TECHNICAL NOTES**

- <sup>1</sup>Limit values
- <sup>2</sup>Average life of 100.000 h with T<sub>A</sub> = +25 °C
- <sup>3</sup>270° single-turn trimmer
- <sup>4</sup>PVC, 4 x 0.14 mm<sup>2</sup>
- <sup>5</sup>Compatible with quick connection systems
- <sup>6</sup>A - reverse polarity protection  
B - overload and short-circuit protection on receiver outputs

		S50-PA-2-B01-NN	S50-PA-2-B01-PP	S50-PA-5-B01-NN	S50-PA-5-B01-PP	S50-PR-2-B01-NN	S50-PR-2-B01-PP	S50-PR-5-B01-NN	S50-PR-5-B01-PP	S50-MA-2-B01-NN	S50-MA-2-B01-PP	S50-MA-5-B01-NN	S50-MA-5-B01-PP	S50-MR-2-B01-NN	S50-MR-2-B01-PP	S50-MR-5-B01-NN	S50-MR-5-B01-PP
<b>Operating distance:</b>																	
axial optics	0.1 ... 4.5 m	•	•	•	•					•	•	•	•				
radial optics	0.1 ... 3 m					•	•	•	•					•	•	•	•
<b>Power supply:</b>	10 ... 30 Vdc <sup>1</sup>	•	•	•	•	•	•	•	•	•	•	•	•	•	•	•	•
<b>Ripple:</b>	≤ 2 Vpp	•	•	•	•	•	•	•	•	•	•	•	•	•	•	•	•
<b>Consumption:</b>	≤35 mA	•	•	•	•	•	•	•	•	•	•	•	•	•	•	•	•
<b>Light emission:</b>	red LED 660 nm <sup>2</sup>	•	•	•	•	•	•	•	•	•	•	•	•	•	•	•	•
<b>Spot dimension:</b>																	
axial optics	approx. 45 mm at 1 m	•	•	•	•					•	•	•	•				
radial optics	approx. 60 mm at 2 m					•	•	•	•					•	•	•	•
<b>Setting:</b>	sensitivity trimmer <sup>3</sup>	•	•	•	•	•	•	•	•	•	•	•	•	•	•	•	•
<b>Indicators:</b>	yellow OUTPUT LED	•	•	•	•	•	•	•	•	•	•	•	•	•	•	•	•
	green STABILITY LED	•	•	•	•	•	•	•	•	•	•	•	•	•	•	•	•
<b>Output type:</b>	PNP, NO and NC																
	NPN, NO and NC	•	•	•	•	•	•	•	•	•	•	•	•	•	•	•	•
<b>Output current:</b>	≤100 mA	•	•	•	•	•	•	•	•	•	•	•	•	•	•	•	•
<b>Saturation voltage:</b>	≤ 2 V	•	•	•	•	•	•	•	•	•	•	•	•	•	•	•	•
<b>Response time:</b>	0.5 ms	•	•	•	•	•	•	•	•	•	•	•	•	•	•	•	•
<b>Switching frequency:</b>	1 kHz	•	•	•	•	•	•	•	•	•	•	•	•	•	•	•	•
<b>Operating mode:</b>	dark on NO / light on NC	•	•	•	•	•	•	•	•	•	•	•	•	•	•	•	•
<b>Connection:</b>	2 m Ø 4 mm cable <sup>4</sup>	•	•			•	•			•	•			•	•		
	M12 4-pole connector <sup>5</sup>			•	•			•	•			•	•			•	•
<b>Electrical protection:</b>	class 2	•	•	•	•	•	•	•	•	•	•	•	•	•	•	•	•
<b>Mechanical protection:</b>	IP67	•	•	•	•	•	•	•	•	•	•	•	•	•	•	•	•
<b>Protection devices:</b>	A, B <sup>6</sup>	•	•	•	•	•	•	•	•	•	•	•	•	•	•	•	•
<b>Housing material:</b>	PBT	•	•	•	•	•	•	•	•	•	•	•	•	•	•	•	•
	nickel plated brass									•	•	•	•	•	•	•	•
<b>Lens material:</b>	PMMA	•	•	•	•	•	•	•	•	•	•	•	•	•	•	•	•
<b>Weight:</b>	75 g max.	•	•			•	•										
	25 g max.			•	•			•	•								
	110 g max.									•	•			•	•		
	60 g max.											•	•			•	•
<b>Operating temperature:</b>	-25 ... +55°C	•	•	•	•	•	•	•	•	•	•	•	•	•	•	•	•
<b>Storage temperature:</b>	-25 ... +70°C	•	•	•	•	•	•	•	•	•	•	•	•	•	•	•	•
<b>Reference standard:</b>	EN 60947-5-2	•	•	•	•	•	•	•	•	•	•	•	•	•	•	•	•

**SELECTION TABLE**

plastic - axial optics - 2 m cable		
S50-PA-2-B01-NN	952001610	NPN
S50-PA-2-B01-PP	952001010	PNP

metal - axial optics - 2 m cable		
S50-MA-2-B01-NN	952021500	NPN
S50-MA-2-B01-PP	952021000	PNP

plastic - axial optics - M12 connector		
S50-PA-5-B01-NN	952001500	NPN
S50-PA-5-B01-PP	952001020	PNP

metal - axial optics - M12 connector		
S50-MA-5-B01-NN	952021660	NPN
S50-MA-5-B01-PP	952021200	PNP

plastic - radial optics - 2 m cable		
S50-PR-2-B01-NN	952001780	NPN
S50-PR-2-B01-PP	952001030	PNP

metal - radial optics - 2 m cable		
S50-MR-2-B01-NN	952021600	NPN
S50-MR-2-B01-PP	952021140	PNP

plastic - radial optics - M12 connector		
S50-PR-5-B01-NN	952001720	NPN
S50-PR-5-B01-PP	952001040	PNP

metal - radial optics - M12 connector		
S50-MR-5-B01-NN	952021760	NPN
S50-MR-5-B01-PP	952021340	PNP

All the ordering codes and information are summarised in the last pages of this catalogue.



\*Only on axial optic models

**DETECTION DIAGRAMS**

axial on R5					4	4.5
axial on R2				3.5	4	
radial on R5	2.5	3				
radial on R2	2	2.5				

- Recommended operating distance
- Maximum operating distance

High efficiency reflectors can be used to obtain larger operating distances. Refer to **Reflectors (A.01)** of the **General Catalogue**.

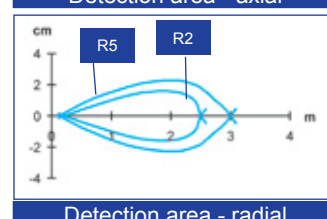
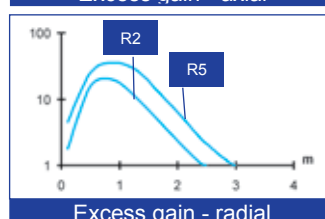
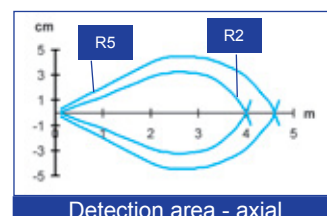
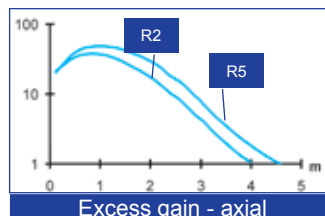

## B LASER RED EMISSION

The visible red laser emission increases the operating distance and resolution of the polarised retroreflex sensor. Specific R7 or R8 reflectors with 0.8 mm microprisms are available for high-resolution detection of small objects. The class 1 laser emission guarantees maximum safety for the operators in all applications.



RADIAL OPTICS

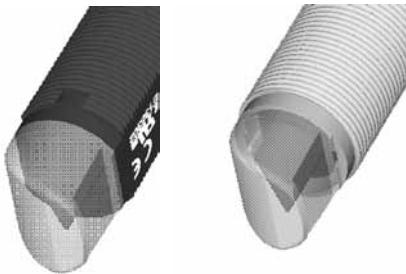

## ACCESSORIES

For **dedicated accessories** refer to the **ACCESSORIES** section of this catalogue.

Refer also to **Reflectors (A.01)**, **Connectors (A.03)** and **Fixing brackets (A.04)** of the General Catalogue.

## DIMENSIONS

### PLASTIC HOUSING

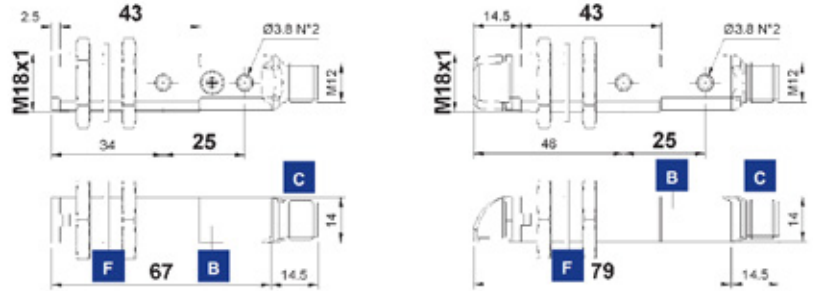

### METAL HOUSING

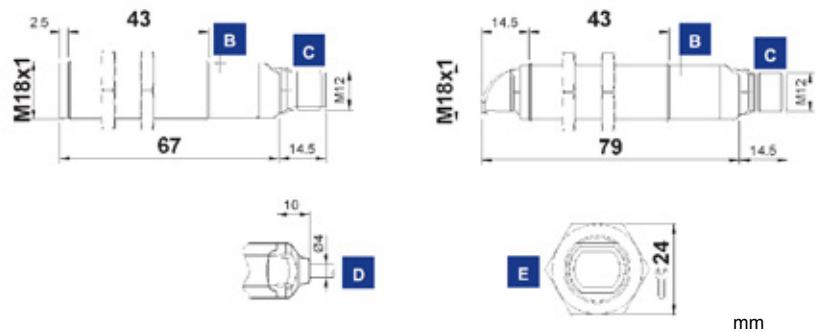

mm

## INDICATORS AND SETTINGS

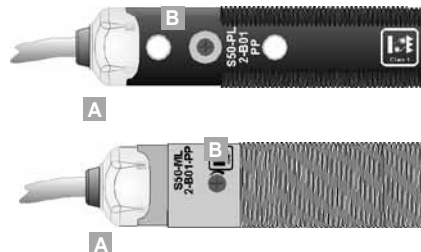

Single-turn trimmer for sensitivity adjustment. Rotate in a clockwise direction to increase the operating distance.

- A** OUTPUT status and stability LEDs
- B** Adjustment trimmer
- C** M12 connector output
- D** Cable output
- E** Fixing nuts
- F** Fixing gasket

## CONNECTIONS

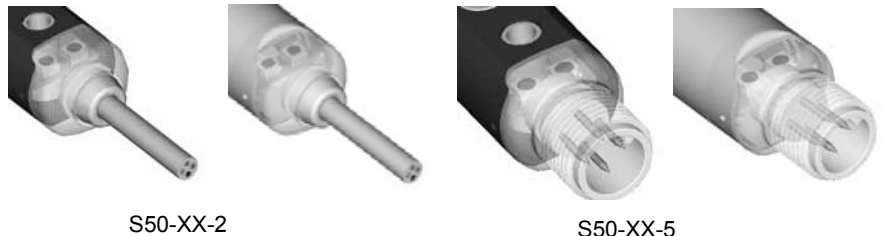

S50-XX-2

S50-XX-5

BROWN	1	+	10 ... 30 Vdc
WHITE	2		NC OUTPUT
BLACK	4		NO OUTPUT
BLUE	3	-	0 V

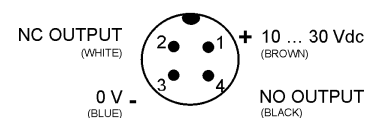

Versions and options: refer to **MODEL ALPHABETICAL INDEX** of this catalogue.

**TECHNICAL DATA**

**SELECTION TABLE**

**TECHNICAL NOTES**

- <sup>1</sup>Limit values
- <sup>2</sup>Average life of 100.000 h with T<sub>A</sub> = +25 °C
- <sup>3</sup>270° single-turn trimmer
- <sup>4</sup>PVC, 4 x 0.14 mm<sup>2</sup>
- <sup>5</sup>Compatible with quick connection systems
- <sup>6</sup>A - reverse polarity protection  
B - overload and short-circuit protection on receiver outputs

		S50-PA-2-B01-NN	S50-PA-2-B01-PP	S50-PA-5-B01-NN	S50-PA-5-B01-PP	S50-PR-2-B01-NN	S50-PR-2-B01-PP	S50-PR-5-B01-NN	S50-PR-5-B01-PP	S50-MA-2-B01-NN	S50-MA-2-B01-PP	S50-MA-5-B01-NN	S50-MA-5-B01-PP	S50-MR-2-B01-NN	S50-MR-2-B01-PP	S50-MR-5-B01-NN	S50-MR-5-B01-PP
<b>Operating distance:</b>																	
axial optics	0.1 ... 16 m	•	•	•	•					•	•	•	•				
radial optics	0.1 ... 9 m					•	•	•	•					•	•	•	•
<b>Power supply:</b>	10 ... 30 Vdc <sup>1</sup>	•	•	•	•	•	•	•	•	•	•	•	•	•	•	•	•
<b>Ripple:</b>	≤ 2 Vpp	•	•	•	•	•	•	•	•	•	•	•	•	•	•	•	•
<b>Consumption:</b>	≤ 35 mA	•	•	•	•	•	•	•	•	•	•	•	•	•	•	•	•
<b>Light emission:</b>	red Laser 650 nm <sup>2</sup> class 1 EN 60825-1	•	•	•	•	•	•	•	•	•	•	•	•	•	•	•	•
	class II CDRH21 CFR 1040.10																
<b>Resolution:</b>	2 mm max. at 3 m (on R7)	•	•	•	•	•	•	•	•	•	•	•	•	•	•	•	•
	5 mm max. over 7 m (on R2)	•	•	•	•	•	•	•	•	•	•	•	•	•	•	•	•
<b>Setting:</b>	sensitivity trimmer <sup>3</sup>	•	•	•	•	•	•	•	•	•	•	•	•	•	•	•	•
<b>Indicators:</b>	yellow OUTPUT LED	•	•	•	•	•	•	•	•	•	•	•	•	•	•	•	•
	green STABILITY LED	•	•	•	•	•	•	•	•	•	•	•	•	•	•	•	•
<b>Output type:</b>	PNP, NO and NC	•	•	•	•	•	•	•	•	•	•	•	•	•	•	•	•
	NPN, NO and NC	•	•	•	•	•	•	•	•	•	•	•	•	•	•	•	•
<b>Output current:</b>	≤ 100 mA	•	•	•	•	•	•	•	•	•	•	•	•	•	•	•	•
<b>Saturation voltage:</b>	≤ 2 V	•	•	•	•	•	•	•	•	•	•	•	•	•	•	•	•
<b>Response time:</b>	333 ms	•	•	•	•	•	•	•	•	•	•	•	•	•	•	•	•
<b>Switching frequency:</b>	1.5 kHz	•	•	•	•	•	•	•	•	•	•	•	•	•	•	•	•
<b>Operating mode:</b>	dark on NO / light on NC	•	•	•	•	•	•	•	•	•	•	•	•	•	•	•	•
<b>Connection:</b>	2 m Ø 4 mm cable <sup>4</sup>	•	•	•	•	•	•	•	•	•	•	•	•	•	•	•	•
	M12 4-pole connector <sup>5</sup>			•	•			•	•			•	•			•	•
<b>Electrical protection:</b>	class 2	•	•	•	•	•	•	•	•	•	•	•	•	•	•	•	•
<b>Mechanical protection:</b>	IP67	•	•	•	•	•	•	•	•	•	•	•	•	•	•	•	•
<b>Protection devices:</b>	A, B <sup>6</sup>	•	•	•	•	•	•	•	•	•	•	•	•	•	•	•	•
<b>Housing material:</b>	PBT	•	•	•	•	•	•	•	•	•	•	•	•	•	•	•	•
	nickel plated brass									•	•	•	•	•	•	•	•
<b>Lens material:</b>	PMMA / glass	•	•	•	•	•	•	•	•	•	•	•	•	•	•	•	•
<b>Weight:</b>	75 g max.	•	•	•	•					•	•	•	•				
	25 g max.					•	•	•	•					•	•	•	•
	110 g max.									•	•	•	•				
	60 g max.													•	•	•	•
<b>Operating temperature:</b>	-10 ... +50°C	•	•	•	•	•	•	•	•	•	•	•	•	•	•	•	•
<b>Storage temperature:</b>	-25 ... +70°C	•	•	•	•	•	•	•	•	•	•	•	•	•	•	•	•
<b>Reference standard:</b>	EN 60947-5-2, EN 60825-1,	•	•	•	•	•	•	•	•	•	•	•	•	•	•	•	•
	CDRH21 CFR 1040.10	•	•	•	•	•	•	•	•	•	•	•	•	•	•	•	•

plastic - axial optics - 2 m cable		
S50-PL-2-B01-NN	952001870	NPN
S50-PL-2-B01-PP	952001360	PNP
plastic - radial optics - 2 m cable		
S50-PH-2-B01-NN	952001950	NPN
S50-PH-2-B01-PP	952001940	PNP
metal - axial optics - 2 m cable		
S50-ML-2-B01-NN	952021820	NPN
S50-ML-2-B01-PP	952021400	PNP
metal - radial optics - 2 m cable		
S50-MH-2-B01-NN	952021950	NPN
S50-MH-2-B01-PP	952021940	PNP
plastic - axial optics - M12 connector		
S50-PL-5-B01-NN	952001840	NPN
S50-PL-5-B01-PP	952001370	PNP
plastic - radial optics - M12 connector		
S50-PH-5-B01-NN	952001970	NPN
S50-PH-5-B01-PP	952001960	PNP
metal - axial optics - M12 connector		
S50-ML-5-B01-NN	952021850	NPN
S50-ML-5-B01-PP	952021440	PNP
metal - radial optics - M12 connector		
S50-MH-5-B01-NN	952021970	NPN
S50-MH-5-B01-PP	952021960	PNP

All the ordering codes and information are summarised in the last pages of this catalogue.

The use of the MICRO-18 fixing bracket (cod. 95ACC1380) is recommended for the correct optic axis alignment of the laser emission.



\*Only on axial optic models

**DETECTION DIAGRAMS**

axial on R2	16
axial on R7	11
radial on R2	9
radial on R7	6

8      12      16 (m)

Operating distance

High efficiency reflectors can be used to obtain larger operating distances. Refer to **Reflectors (A.01)** of the **General Catalogue**.

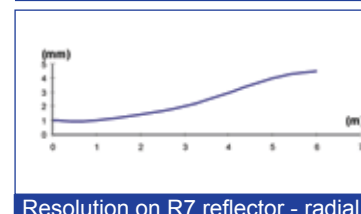
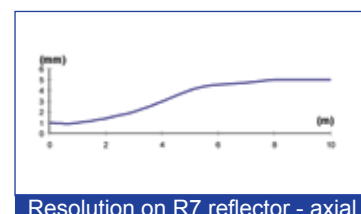
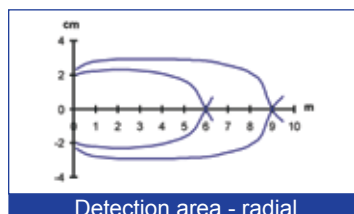
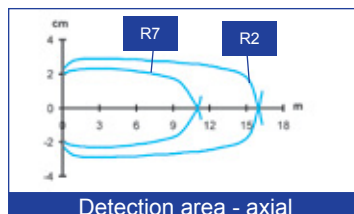

## T RED EMISSION

With high sensitivity and reduced hysteresis this retroreflex sensor allows the detection of even a small variation of the light emission received by the sensor, typically created by the presence of transparent objects such as glass or PET containers or plastic film sheets for packaging. The presence of polarising filters avoids false switching on shiny surfaces.



RADIAL OPTICS

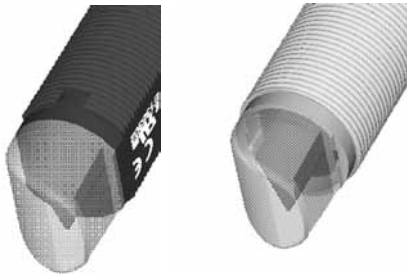

## ACCESSORIES

For **dedicated accessories** refer to the **ACCESSORIES** section of this catalogue.

Refer also to **Connectors and Fixing brackets** of the **General Catalogue**.

## DIMENSIONS

### PLASTIC HOUSING

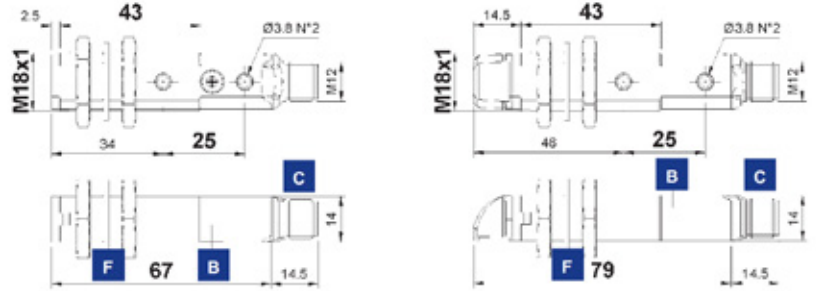

### METAL HOUSING

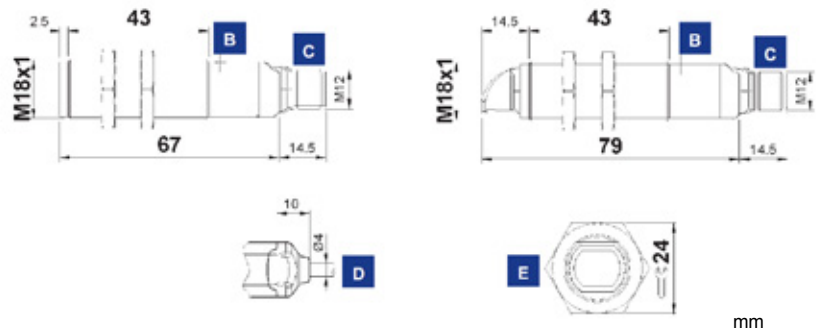

mm

## INDICATORS AND SETTINGS

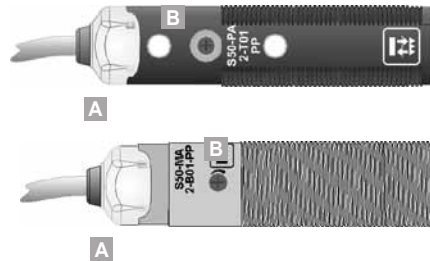

- A** OUTPUT status LEDs
- B** Adjustment trimmer
- C** M12 connector output
- D** Cable output
- E** Fixing nuts
- F** Fixing gasket

## CONNECTIONS

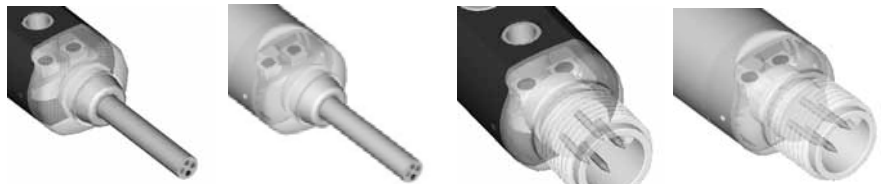

S50-XX-2

S50-XX-5

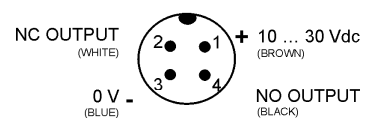
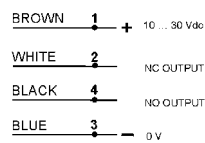

Versions and options: refer to **MODEL ALPHABETICAL INDEX** of this catalogue.



**TECHNICAL DATA**

**TECHNICAL NOTES**

- <sup>1</sup>Limit values
- <sup>2</sup>Average life of 100.000 h with T<sub>A</sub> = +25 °C
- <sup>3</sup>270° single-turn trimmer
- <sup>4</sup>PVC, 4 x 0.14 mm<sup>2</sup>
- <sup>5</sup>Compatible with quick connection systems
- <sup>6</sup>A - reverse polarity protection  
B - overload and short-circuit protection on receiver outputs

		S50-PA-2-T01-NN	S50-PA-2-T01-PP	S50-PA-5-T01-NN	S50-PA-5-T01-PP	S50-PR-2-T01-NN	S50-PR-2-T01-PP	S50-PR-5-T01-NN	S50-PR-5-T01-PP	S50-MA-2-T01-NN	S50-MA-2-T01-PP	S50-MA-5-T01-NN	S50-MA-5-T01-PP	S50-MR-2-T01-NN	S50-MR-2-T01-PP	S50-MR-5-T01-NN	S50-MR-5-T01-PP
<b>Operating distance:</b>																	
axial optics	0.1 ... 1.7 m	•	•	•	•					•	•	•	•				
radial optics	0.1 ... 1.7 m					•	•	•	•					•	•	•	•
<b>Power supply:</b>	10 ... 30 Vdc <sup>1</sup>	•	•	•	•	•	•	•	•	•	•	•	•	•	•	•	•
<b>Ripple:</b>	≤ 2 Vpp	•	•	•	•	•	•	•	•	•	•	•	•	•	•	•	•
<b>Consumption:</b>	≤ 35 mA	•	•	•	•	•	•	•	•	•	•	•	•	•	•	•	•
<b>Light emission:</b>	red LED 660 nm <sup>2</sup>	•	•	•	•	•	•	•	•	•	•	•	•	•	•	•	•
<b>Spot dimension:</b>																	
axial optics	approx. 45 mm at 1 m	•	•	•	•					•	•	•	•				
radial optics	approx. 60 mm at 1 m					•	•	•	•					•	•	•	•
<b>Setting:</b>	sensitivity trimmer <sup>3</sup>	•	•	•	•	•	•	•	•	•	•	•	•	•	•	•	•
<b>Indicators:</b>	yellow OUTPUT LED	•	•	•	•	•	•	•	•	•	•	•	•	•	•	•	•
<b>Output type:</b>	PNP, NO and NC		•		•		•		•		•		•		•		•
	NPN, NO and NC	•		•		•		•		•		•		•		•	
<b>Output current:</b>	≤ 100 mA	•	•	•	•	•	•	•	•	•	•	•	•	•	•	•	•
<b>Saturation voltage:</b>	≤ 2 V	•	•	•	•	•	•	•	•	•	•	•	•	•	•	•	•
<b>Response time:</b>	0.5 ms	•	•	•	•	•	•	•	•	•	•	•	•	•	•	•	•
<b>Switching frequency:</b>	1 kHz	•	•	•	•	•	•	•	•	•	•	•	•	•	•	•	•
<b>Operating mode:</b>	dark on NO / light on NC	•	•	•	•	•	•	•	•	•	•	•	•	•	•	•	•
<b>Connection:</b>	2 m Ø 4 mm cable <sup>4</sup>	•	•			•	•			•	•			•	•		
	M12 4-pole connector <sup>5</sup>			•	•			•	•			•	•			•	•
<b>Electrical protection:</b>	class 2	•	•	•	•	•	•	•	•	•	•	•	•	•	•	•	•
<b>Mechanical protection:</b>	IP67	•	•	•	•	•	•	•	•	•	•	•	•	•	•	•	•
<b>Protection devices:</b>	A, B <sup>6</sup>	•	•	•	•	•	•	•	•	•	•	•	•	•	•	•	•
<b>Housing material:</b>	PBT	•	•	•	•	•	•	•	•	•	•	•	•	•	•	•	•
	nickel plated brass									•	•	•	•				
<b>Lens material:</b>	PMMA	•	•	•	•	•	•	•	•	•	•	•	•	•	•	•	•
<b>Weight:</b>	75 g max.	•	•			•	•										
	25 g max.			•	•			•	•								
	110 g max.									•	•			•	•		
	60 g max.											•	•			•	•
<b>Operating temperature:</b>	-25 ... +55 °C	•	•	•	•	•	•	•	•	•	•	•	•	•	•	•	•
<b>Storage temperature:</b>	-25 ... +70 °C	•	•	•	•	•	•	•	•	•	•	•	•	•	•	•	•
<b>Reference standard:</b>	EN 60947-5-2	•	•	•	•	•	•	•	•	•	•	•	•	•	•	•	•

**SELECTION TABLE**

plastic - axial optics - 2 m cable		
S50-PA-2-T01-NN	952001690	NPN
S50-PA-2-T01-PP	952001260	PNP
metal - axial optics - 2 m cable		
S50-MA-2-T01-NN	952021570	NPN
S50-MA-2-T01-PP	952021090	PNP
plastic - axial optics - M12 connector		
S50-PA-5-T01-NN	952001580	NPN
S50-PA-5-T01-PP	952001270	PNP
metal - axial optics - M12 connector		
S50-MA-5-T01-NN	952021730	NPN
S50-MA-5-T01-PP	952021290	PNP
plastic - radial optics - 2 m cable		
S50-PR-2-T01-NN	952001830	NPN
S50-PR-2-T01-PP	952001280	PNP
metal - radial optics - 2 m cable		
S50-MR-2-T01-NN	952021650	NPN
S50-MR-2-T01-PP	952021190	PNP
plastic - radial optics - M12 connector		
S50-PR-5-T01-NN	952001770	NPN
S50-PR-5-T01-PP	952001290	PNP
metal - radial optics - M12 connector		
S50-MR-5-T01-NN	952021810	NPN
S50-MR-5-T01-PP	952021390	PNP

All the ordering codes and information are summarised in the last pages of this catalogue.



\*Only on axial optic models

**DETECTION DIAGRAMS**

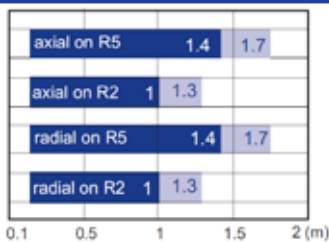

■ Recommended operating distance  
■ Maximum operating distance

High efficiency reflectors can be used to obtain larger operating distances. Refer to **Reflectors** of the **General Catalogue**.

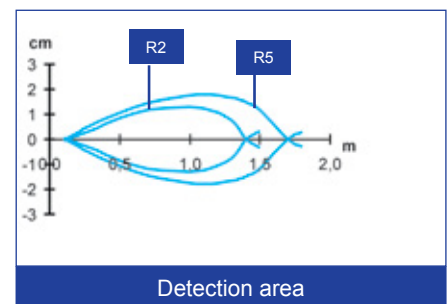
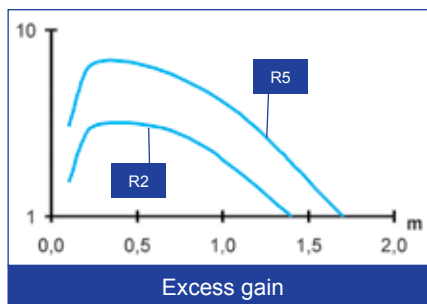

## C SHORT INFRARED EMISSION

This diffuse proximity sensor represents a reliable, simple and cost-effective solution for the direct detection of any object inside the fixed operating distance. Its particularly compact dimensions permit the installation in very small spaces.



RADIAL OPTICS

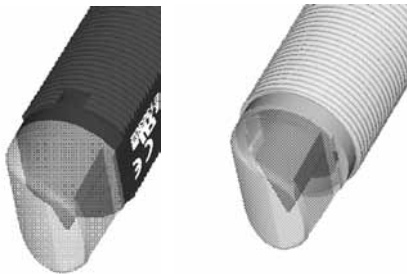

## ACCESSORIES

For **dedicated accessories** refer to the **ACCESSORIES** section of this catalogue.

Refer also to **Connectors and Fixing brackets** of the **General Catalogue**.

## DIMENSIONS

### PLASTIC HOUSING

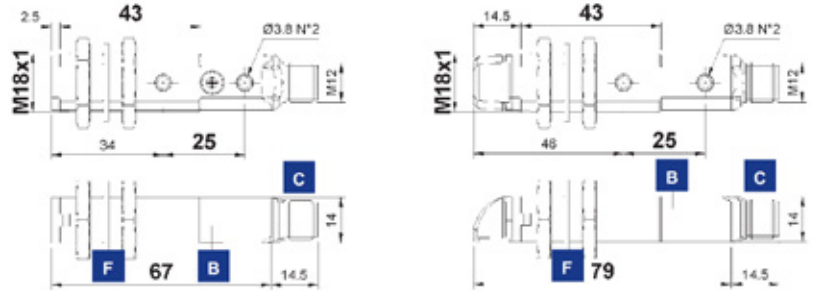

### METAL HOUSING

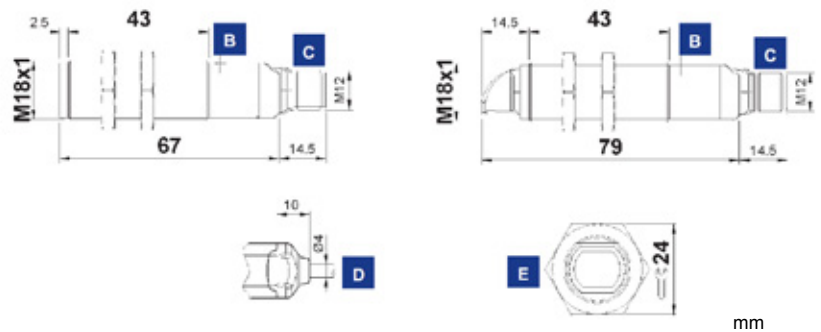

mm

## INDICATORS AND SETTINGS

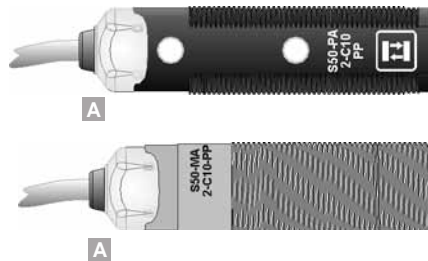

- A** OUTPUT status LEDs
- C** M12 connector output
- D** Cable output
- E** Fixing nuts
- F** Fixing gasket

## CONNECTIONS

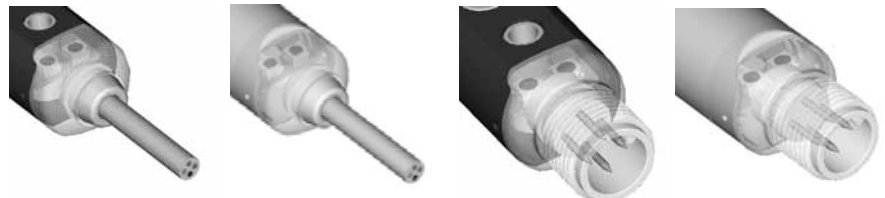

S50-XX-2

S50-XX-5

BROWN	1	+	10 ... 30 Vdc
WHITE	2		NC OUTPUT
BLACK	4		NO OUTPUT
BLUE	3	-	0 V

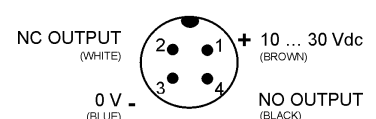

Versions and options: refer to **MODEL ALPHABETICAL INDEX** of this catalogue.

**TECHNICAL DATA**

**TECHNICAL NOTES**

- <sup>1</sup>Limit values
- <sup>2</sup>Average life of 100.000 h with T<sub>A</sub> = +25 °C
- <sup>3</sup>PVC, 4 x 0.14 mm<sup>2</sup>
- <sup>4</sup>Compatible with quick connection systems
- <sup>5</sup>A - reverse polarity protection
- B - overload and short-circuit protection on receiver outputs

		S50-PA-2-C10-NN	S50-PA-2-C10-PP	S50-PA-5-C10-NN	S50-PA-5-C10-PP	S50-PR-2-C10-NN	S50-PR-2-C10-PP	S50-PR-5-C10-NN	S50-PR-5-C10-PP	S50-MA-2-C10-NN	S50-MA-2-C10-PP	S50-MA-5-C10-NN	S50-MA-5-C10-PP	S50-MR-2-C10-NN	S50-MR-2-C10-PP	S50-MR-5-C10-NN	S50-MR-5-C10-PPx
<b>Operating distance:</b>																	
axial optics	0 ... 10 cm	•	•	•	•					•	•	•	•				
radial optics	0 ... 8 cm					•	•	•	•					•	•	•	•
<b>Power supply:</b>	10 ... 30 Vdc <sup>1</sup>	•	•	•	•	•	•	•	•	•	•	•	•	•	•	•	•
<b>Ripple:</b>	≤ 2 Vpp	•	•	•	•	•	•	•	•	•	•	•	•	•	•	•	•
<b>Consumption:</b>	≤ 35 mA	•	•	•	•	•	•	•	•	•	•	•	•	•	•	•	•
<b>Light emission:</b>	infrared LED 880 nm <sup>2</sup>	•	•	•	•	•	•	•	•	•	•	•	•	•	•	•	•
<b>Spot dimension:</b>																	
axial optics	approx. 80 mm at 10 cm	•	•	•	•					•	•	•	•				
radial optics	approx. 55 mm at 10 cm					•	•	•	•					•	•	•	•
<b>Indicators:</b>	yellow OUTPUT LED	•	•	•	•	•	•	•	•	•	•	•	•	•	•	•	•
<b>Output type:</b>	PNP, NO and NC		•		•		•		•		•		•		•		•
	NPN, NO and NC	•		•		•		•		•		•		•		•	
Output current:	≤ 100 mA	•	•	•	•	•	•	•	•	•	•	•	•	•	•	•	•
<b>Saturation voltage:</b>	≤ 2 V	•	•	•	•	•	•	•	•	•	•	•	•	•	•	•	•
<b>Response time:</b>	0.5 ms	•	•	•	•	•	•	•	•	•	•	•	•	•	•	•	•
<b>Switching frequency:</b>	1 kHz	•	•	•	•	•	•	•	•	•	•	•	•	•	•	•	•
<b>Operating mode:</b>	dark on NO / light on NC	•	•	•	•	•	•	•	•	•	•	•	•	•	•	•	•
<b>Connection:</b>	2 m Ø 4 mm cable <sup>3</sup>	•	•			•	•			•	•			•	•		
	M12 4-pole connector <sup>4</sup>			•	•			•	•			•	•			•	•
<b>Electrical protection:</b>	class 2	•	•	•	•	•	•	•	•	•	•	•	•	•	•	•	•
<b>Mechanical protection:</b>	IP67	•	•	•	•	•	•	•	•	•	•	•	•	•	•	•	•
<b>Protection devices:</b>	A, B <sup>5</sup>	•	•	•	•	•	•	•	•	•	•	•	•	•	•	•	•
<b>Housing material:</b>	PBT	•	•	•	•	•	•	•	•	•	•	•	•	•	•	•	•
	nickel plated brass									•	•	•	•	•	•	•	•
<b>Lens material:</b>	PMMA	•	•	•	•	•	•	•	•	•	•	•	•	•	•	•	•
<b>Weight:</b>	75 g max.	•	•			•	•										
	25 g max.			•	•			•	•								
	110 g max.									•	•			•	•		
	60 g max.											•	•			•	•
<b>Operating temperature:</b>	-25 ... +55°C	•	•	•	•	•	•	•	•	•	•	•	•	•	•	•	•
<b>Storage temperature:</b>	-25 ... +70°C	•	•	•	•	•	•	•	•	•	•	•	•	•	•	•	•
<b>Reference standard:</b>	EN 60947-5-2	•	•	•	•	•	•	•	•	•	•	•	•	•	•	•	•

**SELECTION TABLE**

plastic - axial optics - 2 m cable		
S50-PA-2-C10-NN	952001630	NPN
S50-PA-2-C10-PP	952001240	PNP
metal - axial optics - 2 m cable		
S50-MA-2-C10-NN	952021520	NPN
S50-MA-2-C10-PP	952021020	PNP
plastic - axial optics - M12 connector		
S50-PA-5-C10-NN	952001520	NPN
S50-PA-5-C10-PP	952001250	PNP
metal - axial optics - M12 connector		
S50-MA-5-C10-NN	952021680	NPN
S50-MA-5-C10-PP	952021220	PNP
plastic - radial optics - 2 m cable		
S50-PR-2-C10-NN	952001800	NPN
S50-PR-2-C10-PP	952001490	PNP
metal - radial optics - 2 m cable		
S50-MR-2-C10-NN	952021620	NPN
S50-MR-2-C10-PP	952021490	PNP
plastic - radial optics - M12 connector		
S50-PR-5-C10-NN	952001740	NPN
S50-PR-5-C10-PP	952001480	PNP
metal - radial optics - M12 connector		
S50-MR-5-C10-NN	952021780	NPN
S50-MR-5-C10-PP	952021480	PNP

All the ordering codes and information are summarised in the last pages of this catalogue.



\*Only on axial optic models

**DETECTION DIAGRAMS**

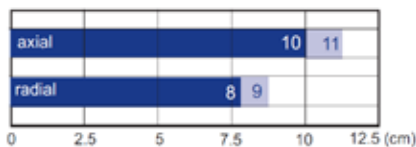

■ Recommended operating distance  
 ■ Maximum operating distance

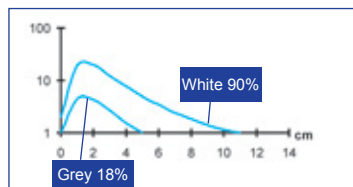

Excess gain - axial

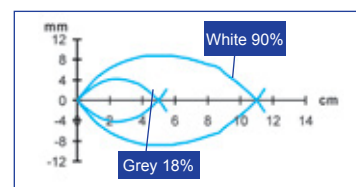

Detection area - axial

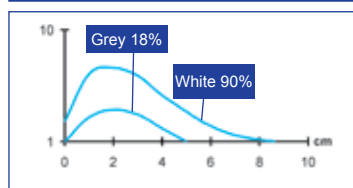

Excess gain - radial

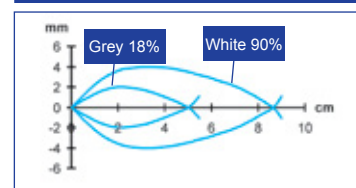

Detection area - radial

## C MID INFRARED EMISSION

This version of diffuse proximity sensor has a detection distance that can be set using the sensitivity adjustment trimmer. The green stability LED indicates whether the received signal is above to the minimum signal for stable output switching.



## DIMENSIONS

### PLASTIC HOUSING

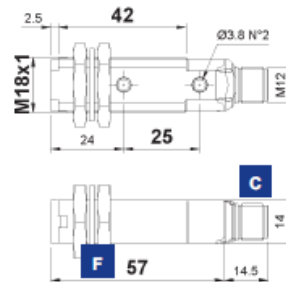

### METAL HOUSING

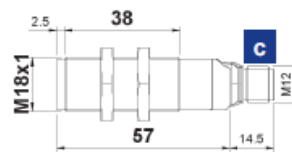

## INDICATORS AND SETTINGS

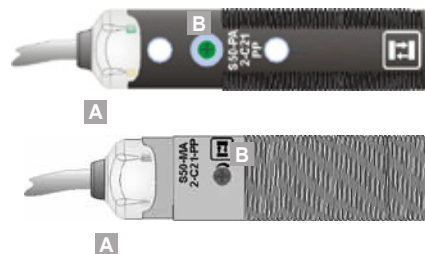

- A** OUTPUT status and stability LEDs
- B** Adjustment trimmer
- C** M12 connector output
- D** Cable output
- E** Fixing nuts
- F** Fixing gasket

Single-turn trimmer for sensitivity adjustment. Rotate in a clockwise direction to increase the operating distance.

## ACCESSORIES

For **dedicated accessories** refer to the **ACCESSORIES** section of this catalogue.

Refer also to **Connectors and Fixing brackets** of the **General Catalogue**.

## CONNECTIONS

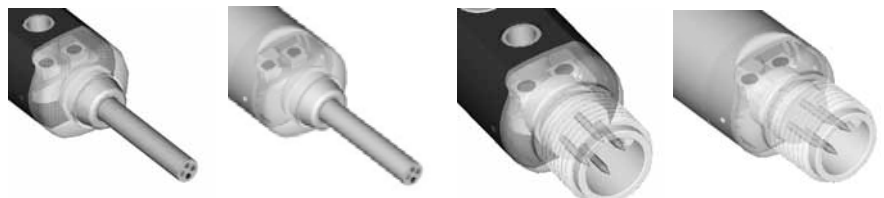

S50-XX-2

S50-XX-5

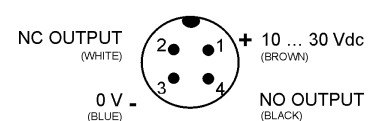
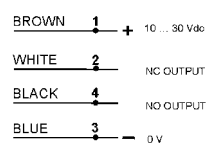

Versions and options: refer to **MODEL ALPHABETICAL INDEX** of this catalogue.

**TECHNICAL DATA**

**TECHNICAL NOTES**

- <sup>1</sup>Limit values
- <sup>2</sup>Average life of 100.000 h with TA = +25 °C
- <sup>3</sup>270° single-turn trimmer
- <sup>4</sup>PVC, 4 x 0.14 mm<sup>2</sup>
- <sup>5</sup>Compatible with quick connection systems
- <sup>6</sup>A - reverse polarity protection
- B - overload and short-circuit protection on receiver outputs

		S50-PA-2-C21-NN	S50-PA-2-C21-PP	S50-PA-5-C21-NN	S50-PA-5-C21-PP	S50-MA-2-C21-NN	S50-MA-2-C21-PP	S50-MA-5-C21-NN	S50-MA-5-C21-PP
<b>Operating distance:</b>	0 ... 40 cm	•	•	•	•	•	•	•	•
<b>Power supply:</b>	10 ... 30 Vdc <sup>1</sup>	•	•	•	•	•	•	•	•
<b>Ripple:</b>	≤ 2 Vpp	•	•	•	•	•	•	•	•
<b>Consumption:</b>	≤ 35 mA	•	•	•	•	•	•	•	•
<b>Light emission:</b>	infrared LED 880 nm <sup>2</sup>	•	•	•	•	•	•	•	•
<b>Spot dimension:</b>	approx. 100 mm at 300 cm	•	•	•	•	•	•	•	•
<b>Setting:</b>	sensitivity trimmer <sup>3</sup>	•	•	•	•	•	•	•	•
<b>Indicators:</b>	yellow OUTPUT LED	•	•	•	•	•	•	•	•
	green STABILITY LED	•	•	•	•	•	•	•	•
<b>Output type:</b>	PNP, NO and NC		•	•	•		•		•
	NPN, NO and NC	•		•		•		•	
<b>Output current:</b>	≤ 100 mA	•	•	•	•	•	•	•	•
<b>Saturation voltage:</b>	≤ 2 V	•	•	•	•	•	•	•	•
<b>Response time:</b>	0.5 ms	•	•	•	•	•	•	•	•
<b>Switching frequency:</b>	1 kHz	•	•	•	•	•	•	•	•
<b>Operating mode:</b>	light on NO / dark on NC	•	•	•	•	•	•	•	•
<b>Connection:</b>	2 m Ø 4 mm cable <sup>4</sup>	•	•			•	•		
	M12 4-pole connector <sup>5</sup>			•	•			•	•
<b>Electrical protection:</b>	class 2	•	•	•	•	•	•	•	•
<b>Mechanical protection:</b>	IP67	•	•	•	•	•	•	•	•
<b>Protection devices:</b>	A, B <sup>6</sup>	•	•	•	•	•	•	•	•
<b>Housing material:</b>	PBT	•	•	•	•				
	nickel plated brass					•	•	•	•
<b>Lens material:</b>	PMMA	•	•	•	•	•	•	•	•
<b>Weight:</b>	75 g max.	•	•						
	25 g max.			•	•				
	110 g max.					•	•		
	60 g max.							•	•
<b>Operating temperature:</b>	-25 ... +55°C	•	•	•	•	•	•	•	•
<b>Storage temperature:</b>	-25 ... +70°C	•	•	•	•	•	•	•	•
<b>Reference standard:</b>	EN 60947-5-2	•	•	•	•	•	•	•	•

**SELECTION TABLE**

plastic - axial optics - 2 m cable		
S50-PA-2-C21-NN	952002170	NPN
S50-PA-2-C21-PP	952002160	PNP

metal - axial optics - 2 m cable		
S50-MA-2-C21-NN	952022130	NPN
S50-MA-2-C21-PP	952022120	PNP

plastic - axial optics - M12 connector		
S50-PA-5-C21-NN	952002190	NPN
S50-PA-5-C21-PP	952002180	PNP

metal - axial optics - M12 connector		
S50-MA-5-C21-NN	952022150	NPN
S50-MA-5-C21-PP	952022140	PNP

All the ordering codes and information are summarised in the last pages of this catalogue.



**DETECTION DIAGRAMS**

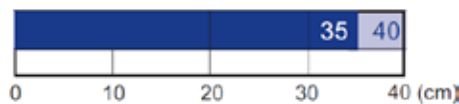

- Recommended operating distance
- Maximum operating distance

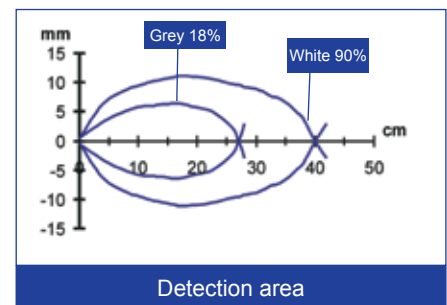
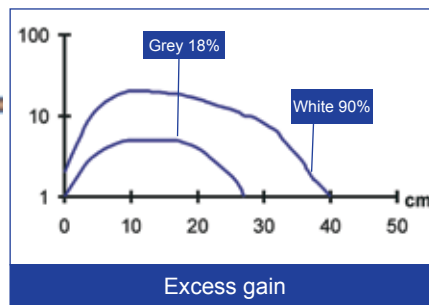

## C LONG INFRARED EMISSION

This version of diffuse proximity sensor has a detection distance that can be set using the sensitivity adjustment trimmer. The green stability LED indicates whether the received signal is above to the minimum signal for stable output switching.



RADIAL OPTICS

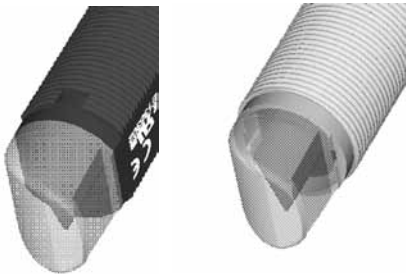

## ACCESSORIES

For **dedicated accessories** refer to the **ACCESSORIES** section of this catalogue.

Refer also to **Connectors and Fixing brackets of the General Catalogue**.

## DIMENSIONS

### PLASTIC HOUSING

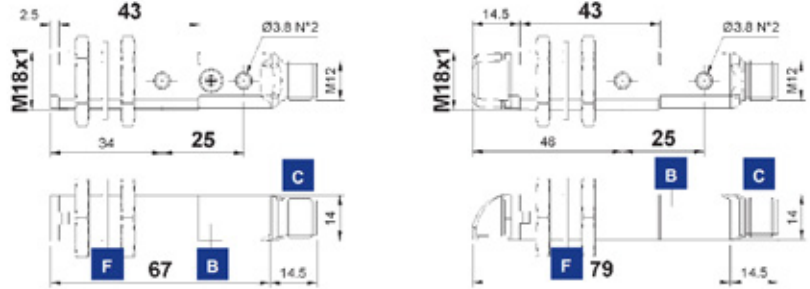

### METAL HOUSING

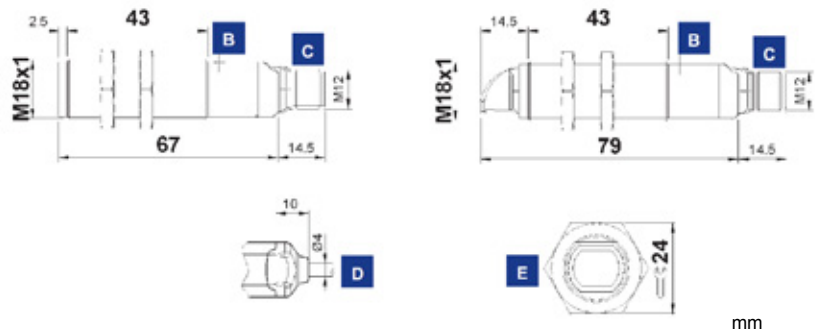

mm

## INDICATORS AND SETTINGS

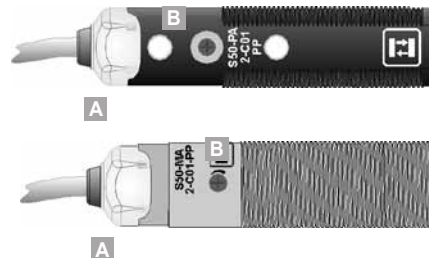

- A** OUTPUT status and STABILITY LEDs
- B** Adjustment trimmer
- C** M12 connector output
- D** Cable output
- E** Fixing nuts
- F** Fixing gasket

## CONNECTIONS

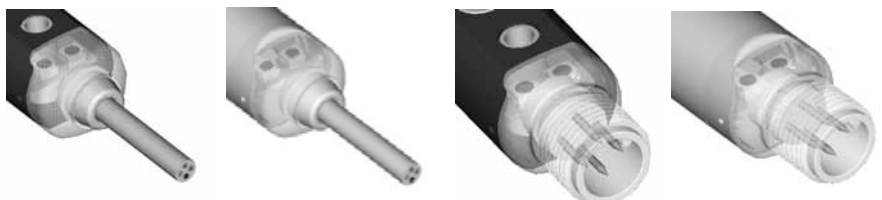

S50-XX-2

S50-XX-5

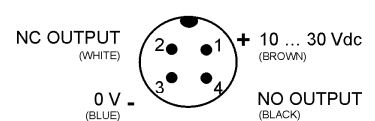
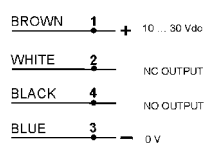

Versions and options: refer to **MODEL ALPHABETICAL INDEX** of this catalogue.

**TECHNICAL DATA**

**TECHNICAL NOTES**

- <sup>1</sup>Limit values
- <sup>2</sup>Average life of 100.000 h with T<sub>A</sub> = +25 °C
- <sup>3</sup>270° single-turn trimmer
- <sup>4</sup>PVC, 4 x 0.14 mm<sup>2</sup>
- <sup>5</sup>Compatible with quick connection systems
- <sup>6</sup>A - reverse polarity protection
- B - overload and short-circuit protection on receiver outputs

		S50-PA-2-C01-NN	S50-PA-2-C01-PP	S50-PA-5-C01-NN	S50-PA-5-C01-PP	S50-PR-2-C01-NN	S50-PR-2-C01-PP	S50-PR-5-C01-NN	S50-PR-5-C01-PP	S50-MA-2-C01-NN	S50-MA-2-C01-PP	S50-MA-5-C01-NN	S50-MA-5-C01-PP	S50-MR-2-C01-NN	S50-MR-2-C01-PP	S50-MR-5-C01-NN	S50-MR-5-C01-PP
<b>Operating distance:</b>																	
axial optics	0 ... 70 cm	•	•	•	•					•	•	•	•				
radial optics	0 ... 40 cm					•	•	•	•					•	•	•	•
<b>Power supply:</b>	10 ... 30 Vdc <sup>1</sup>	•	•	•	•	•	•	•	•	•	•	•	•	•	•	•	•
<b>Ripple:</b>	≤2 Vpp	•	•	•	•	•	•	•	•	•	•	•	•	•	•	•	•
<b>Consumption:</b>	≤35 mA	•	•	•	•	•	•	•	•	•	•	•	•	•	•	•	•
<b>Light emission:</b>	infrared LED 880 nm <sup>2</sup>	•	•	•	•	•	•	•	•	•	•	•	•	•	•	•	•
<b>Spot dimension:</b>																	
axial optics	approx.200 mm at 60 cm	•	•	•	•					•	•	•	•				
radial optics	approx.35 mm at 40 cm					•	•	•	•					•	•	•	•
<b>Setting:</b>	sensitivity trimmer <sup>3</sup>	•	•	•	•	•	•	•	•	•	•	•	•	•	•	•	•
<b>Indicators:</b>	yellow OUTPUT LED	•	•	•	•	•	•	•	•	•	•	•	•	•	•	•	•
	green STABILITY LED	•	•	•	•	•	•	•	•	•	•	•	•	•	•	•	•
<b>Output type:</b>	PNP, NO and NC		•		•		•		•		•		•		•		•
	NPN, NO and NC	•		•		•		•		•		•		•		•	
<b>Output current:</b>	≤100 mA	•	•	•	•	•	•	•	•	•	•	•	•	•	•	•	•
<b>Saturation voltage:</b>	≤2 V	•	•	•	•	•	•	•	•	•	•	•	•	•	•	•	•
<b>Response time:</b>	0.5 ms	•	•	•	•	•	•	•	•	•	•	•	•	•	•	•	•
<b>Switching frequency:</b>	1 kHz	•	•	•	•	•	•	•	•	•	•	•	•	•	•	•	•
<b>Operating mode:</b>	dark on NO / light on NC	•	•	•	•	•	•	•	•	•	•	•	•	•	•	•	•
<b>Connection:</b>	2 m Ø 4 mm cable <sup>4</sup>	•	•			•	•			•	•			•	•		
	M12 4-pole connector <sup>5</sup>			•	•			•	•			•	•			•	•
<b>Electrical protection:</b>	class 2	•	•	•	•	•	•	•	•	•	•	•	•	•	•	•	•
<b>Mechanical protection:</b>	IP67	•	•	•	•	•	•	•	•	•	•	•	•	•	•	•	•
<b>Protection devices:</b>	A, B <sup>6</sup>	•	•	•	•	•	•	•	•	•	•	•	•	•	•	•	•
<b>Housing material:</b>	PBT	•	•	•	•	•	•	•	•	•	•	•	•	•	•	•	•
	nickel plated brass									•	•	•	•				
<b>Lens material:</b>	PMMA	•	•	•	•	•	•	•	•	•	•	•	•	•	•	•	•
<b>Weight:</b>	75 g max.	•	•			•	•										
	25 g max.			•	•			•	•								
	110 g max.									•	•			•	•		
	60 g max.											•	•			•	•
<b>Operating temperature:</b>	-25 ... +55°C	•	•	•	•	•	•	•	•	•	•	•	•	•	•	•	•
<b>Storage temperature:</b>	-25 ... +70°C	•	•	•	•	•	•	•	•	•	•	•	•	•	•	•	•
<b>Reference standard:</b>	EN 60947-5-2	•	•	•	•	•	•	•	•	•	•	•	•	•	•	•	•

**SELECTION TABLE**

plastic - axial optics - 2 m cable		
S50-PA-2-C01-NN	952001620	NPN
S50-PA-2-C01-PP	952001050	PNP
metal - axial optics - 2 m cable		
S50-MA-2-C01-NN	952021510	NPN
S50-MA-2-C01-PP	952021010	PNP
plastic - axial optics - M12 connector		
S50-PA-5-C01-NN	952001510	NPN
S50-PA-5-C01-PP	952001060	PNP
metal - axial optics - M12 connector		
S50-MA-5-C01-NN	952021670	NPN
S50-MA-5-C01-PP	952021210	PNP
plastic - radial optics - 2 m cable		
S50-PR-2-C01-NN	952001790	NPN
S50-PR-2-C01-PP	952001070	PNP
metal - radial optics - 2 m cable		
S50-MR-2-C01-NN	952021610	NPN
S50-MR-2-C01-PP	952021150	PNP
plastic - radial optics - M12 connector		
S50-PR-5-C01-NN	952001730	NPN
S50-PR-5-C01-PP	952001080	PNP
metal - radial optics - M12 connector		
S50-MR-5-C01-NN	952021770	NPN
S50-MR-5-C01-PP	952021350	PNP

All the ordering codes and information are summarised in the last pages of this catalogue.



\*Only on axial optic models

**DETECTION DIAGRAMS**

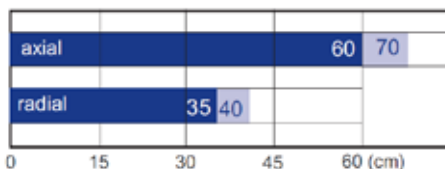

- Recommended operating distance
- Maximum operating distance

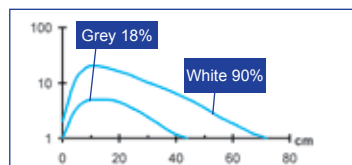

Excess gain - axial

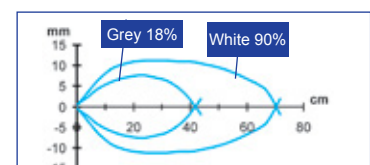

Detection area - axial

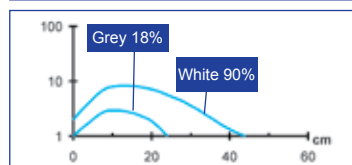

Excess gain - radial

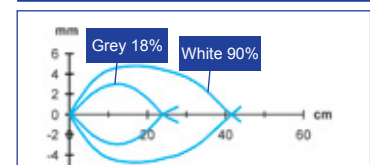

Detection area - radial

## D RED EMISSION

The fixed focus proximity sensor offers a simple fixed background suppression distance beyond which no object is detected. The fixed triangulation of the optics greatly reduces the detection distance of reflective objects. The visible red emission facilitates sensor installation.



RADIAL OPTICS

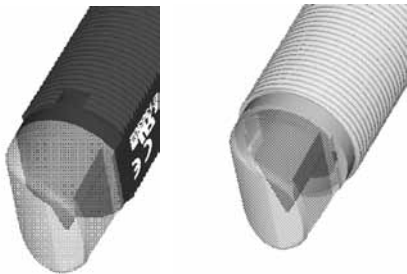

## ACCESSORIES

For **dedicated accessories** refer to the **ACCESSORIES** section of this catalogue.

Refer also to **Connectors and Fixing brackets** of the **General Catalogue**.

## DIMENSIONS

### PLASTIC HOUSING

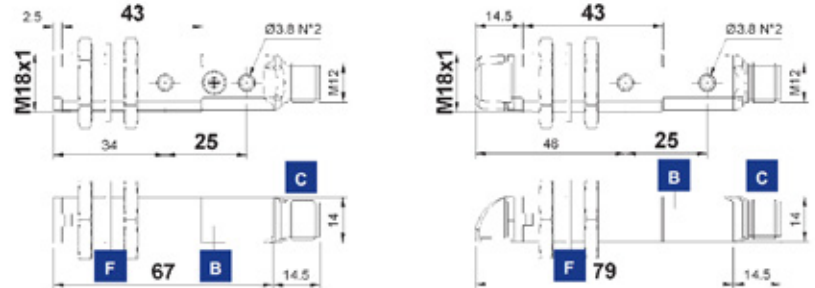

### METAL HOUSING

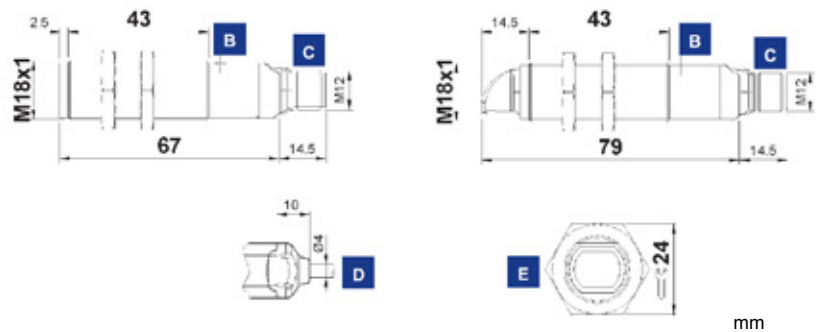

mm

## INDICATORS AND SETTINGS

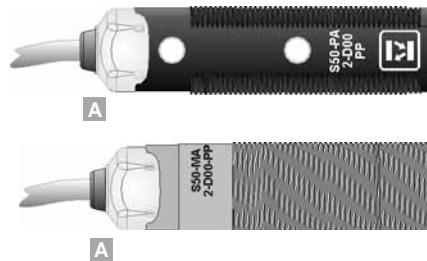

- A** OUTPUT status LED
- C** M12 connector output
- D** Cable output
- E** Fixing nuts
- F** Fixing gasket

## CONNECTIONS

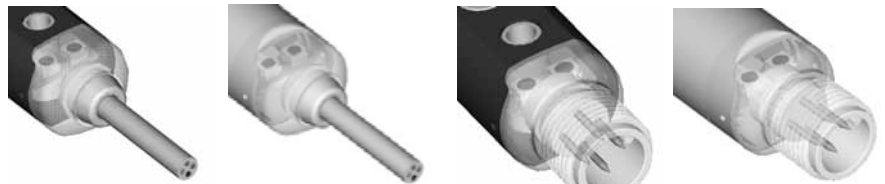

S50-XX-2

S50-XX-5

BROWN	1	+	10 ... 30 Vdc
WHITE	2		NC OUTPUT
BLACK	4		NO OUTPUT
BLUE	3	-	0 V

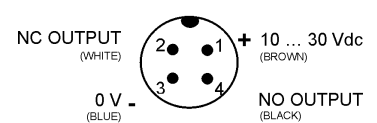

Versions and options: refer to **MODEL ALPHABETICAL INDEX** of this catalogue.



**TECHNICAL DATA**

**SELECTION TABLE**

**TECHNICAL NOTES**

- <sup>1</sup>Limit values
- <sup>2</sup>Average life of 100.000 h with T<sub>a</sub> = +25 °C
- <sup>3</sup>PVC, 4 x 0.14 mm<sup>2</sup>
- <sup>4</sup>Compatible with quick connection systems
- <sup>5</sup>A - reverse polarity protection
- B - overload and short-circuit protection on receiver outputs

		S50-PA-2-D00-NN	S50-PA-2-D00-PP	S50-PA-5-D00-NN	S50-PA-5-D00-PP	S50-PR-2-D00-NN	S50-PR-2-D00-PP	S50-PR-5-D00-NN	S50-PR-5-D00-PP	S50-MA-2-D00-NN	S50-MA-2-D00-PP	S50-MA-5-D00-NN	S50-MA-5-D00-PP	S50-MR-2-D00-NN	S50-MR-2-D00-PP	S50-MR-5-D00-NN	S50-MR-5-D00-PP
<b>Operating distance:</b>																	
axial optics	0.5 ... 10 cm	•	•	•	•					•	•	•	•				
radial optics	0 ... 8 cm					•	•	•	•					•	•	•	•
<b>Power supply:</b>	10 ... 30 Vdc <sup>1</sup>	•	•	•	•	•	•	•	•	•	•	•	•	•	•	•	•
<b>Ripple:</b>	≤ 2 Vpp	•	•	•	•	•	•	•	•	•	•	•	•	•	•	•	•
<b>Consumption:</b>	≤ 35 mA	•	•	•	•	•	•	•	•	•	•	•	•	•	•	•	•
<b>Light emission:</b>	red LED 630 nm <sup>2</sup>	•	•	•	•	•	•	•	•	•	•	•	•	•	•	•	•
<b>Spot dimension:</b>																	
axial optics	approx. 20 mm at 10 cm	•	•	•	•					•	•	•	•				
radial optics	approx. 25 mm at 8 cm					•	•	•	•					•	•	•	•
<b>Indicators:</b>	yellow OUTPUT LED	•	•	•	•	•	•	•	•	•	•	•	•	•	•	•	•
<b>Output type:</b>	PNP, NO and NC		•		•		•		•		•		•		•		•
	NPN, NO and NC	•		•		•		•		•		•		•		•	
<b>Output current:</b>	≤ 100 mA	•	•	•	•	•	•	•	•	•	•	•	•	•	•	•	•
<b>Saturation voltage:</b>	≤ 2 V	•	•	•	•	•	•	•	•	•	•	•	•	•	•	•	•
<b>Response time:</b>	0.5 ms	•	•	•	•	•	•	•	•	•	•	•	•	•	•	•	•
<b>Switching frequency:</b>	1 kHz	•	•	•	•	•	•	•	•	•	•	•	•	•	•	•	•
<b>Operating mode:</b>	dark on NO / light on NC	•	•	•	•	•	•	•	•	•	•	•	•	•	•	•	•
<b>Connection:</b>	2 m Ø 4 mm cable	•	•			•	•			•	•			•	•		
	M12 4-pole connector			•	•			•	•			•	•			•	•
<b>Electrical protection:</b>	class 2	•	•	•	•	•	•	•	•	•	•	•	•	•	•	•	•
<b>Mechanical protection:</b>	IP67	•	•	•	•	•	•	•	•	•	•	•	•	•	•	•	•
<b>Protection devices:</b>	A, B <sup>5</sup>	•	•	•	•	•	•	•	•	•	•	•	•	•	•	•	•
<b>Housing material:</b>	PBT	•	•	•	•	•	•	•	•	•	•	•	•	•	•	•	•
	nickel plated brass									•	•	•	•			•	•
<b>Lens material:</b>	PMMA	•	•	•	•	•	•	•	•	•	•	•	•	•	•	•	•
<b>Weight:</b>	75 g max.	•	•			•	•										
	25 g max.			•	•			•	•								
	110 g max.									•	•			•	•		
	60 g max.											•	•			•	•
<b>Operating temperature:</b>	-25 ... +55°C	•	•	•	•	•	•	•	•	•	•	•	•	•	•	•	•
<b>Storage temperature:</b>	-25 ... +70°C	•	•	•	•	•	•	•	•	•	•	•	•	•	•	•	•
<b>Reference standard:</b>	EN 60947-5-2	•	•	•	•	•	•	•	•	•	•	•	•	•	•	•	•

plastic - axial optics - 2 m cable		
S50-PA-2-D00-NN	952001640	NPN
S50-PA-2-D00-PP	952001090	PNP

metal - axial optics - 2 m cable		
S50-MA-2-D00-NN	952021530	NPN
S50-MA-2-D00-PP	952021030	PNP

plastic - axial optics - M12 connector		
S50-PA-5-D00-NN	952001530	NPN
S50-PA-5-D00-PP	952001100	PNP

metal - axial optics - M12 connector		
S50-MA-5-D00-NN	952021690	NPN
S50-MA-5-D00-PP	952021230	PNP

plastic - radial optics - 2 m cable		
S50-PR-2-D00-NN	952001810	NPN
S50-PR-2-D00-PP	952001110	PNP

metal - radial optics - 2 m cable		
S50-MR-2-D00-NN	952021630	NPN
S50-MR-2-D00-PP	952021160	PNP

plastic - radial optics - M12 connector		
S50-PR-5-D00-NN	952001750	NPN
S50-PR-5-D00-PP	952001120	PNP

metal - radial optics - M12 connector		
S50-MR-5-D00-NN	952021790	NPN
S50-MR-5-D00-PP	952021360	PNP

All the ordering codes and information are summarised in the last pages of this catalogue.



\*Only on axial optic models

**DETECTION DIAGRAMS**



■ Operating distance

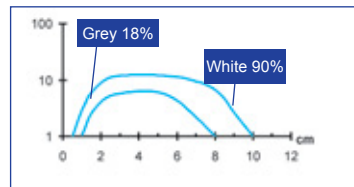

Excess gain - axial



Detection area - axial

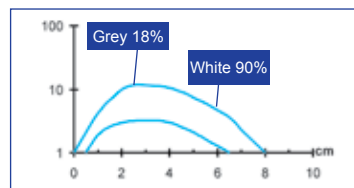

Excess gain - radial

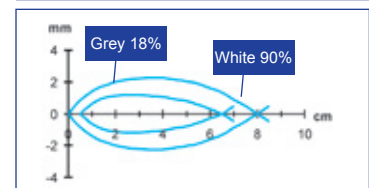

Detection area - radial

## C LASER RED EMISSION

The visible red laser emission allows the accurate detection of very small objects. The sensors operate as a proximity device up to 35 cm and can be used as a contrast sensor for high contrast mark detection. The class 1 laser emission guarantees maximum safety for the operators in all applications.



RADIAL OPTICS

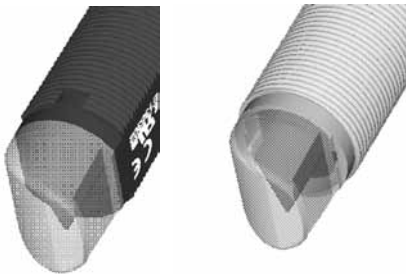

## ACCESSORIES

For **dedicated accessories** refer to the **ACCESSORIES** section of this catalogue.

Refer also to **Connectors and Fixing brackets** of the **General Catalogue**.

## DIMENSIONS

### PLASTIC HOUSING

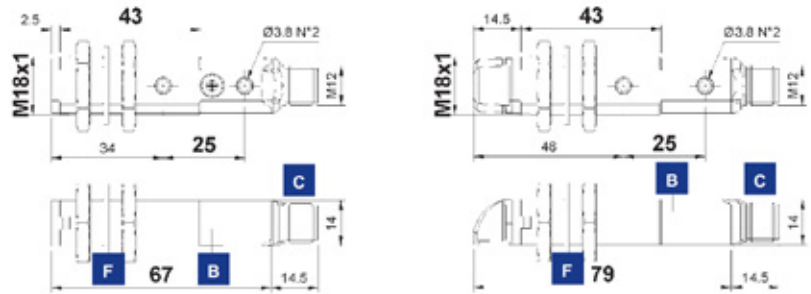

### METAL HOUSING

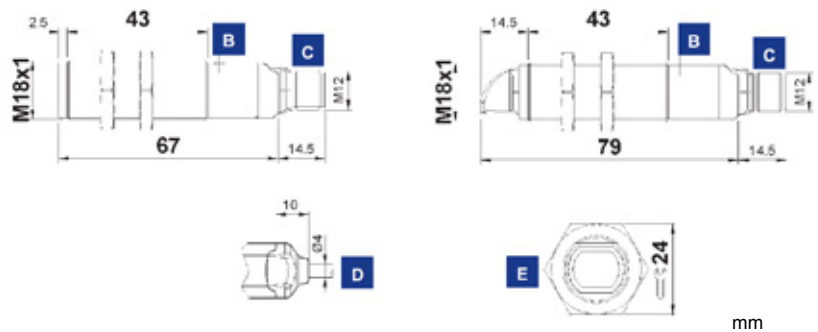

mm

## INDICATORS AND SETTINGS

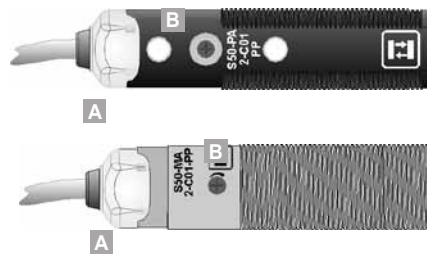

- A** OUTPUT status and stability LEDs
- B** Adjustment trimmer
- C** M12 connector output
- D** Cable output
- E** Fixing nuts
- F** Fixing gasket

Single-turn trimmer for sensitivity adjustment. Rotate in a clockwise direction to increase the operating distance.

## CONNECTIONS

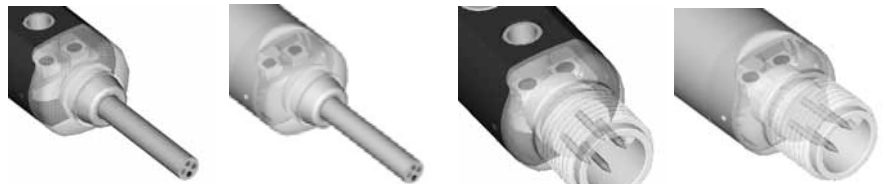

S50-XX-2

S50-XX-5

BROWN	1	+	10 ... 30 Vdc
WHITE	2		NC OUTPUT
BLACK	4		NO OUTPUT
BLUE	3	-	0 V

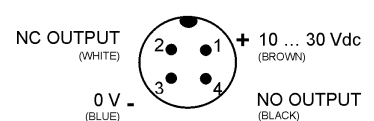

Versions and options: refer to **MODEL ALPHABETICAL INDEX** of this catalogue.

**TECHNICAL DATA**

**TECHNICAL NOTES**

- <sup>1</sup>Limit values
- <sup>2</sup>Average life of 100.000 h with T<sub>A</sub> = +25 °C
- <sup>3</sup>270° single-turn trimmer
- <sup>4</sup>PVC, 4 x 0.14 mm<sup>2</sup>
- <sup>5</sup>Compatible with quick connection systems
- <sup>6</sup>A - reverse polarity protection  
B - overload and short-circuit protection on receiver outputs

		S50-PL-2-C01-NN	S50-PL-2-C01-PP	S50-PH-2-C01-NN	S50-PH-2-C01-PP	S50-PL-5-C01-NN	S50-PL-5-C01-PP	S50-PH-5-C01-NN	S50-PH-5-C01-PP	S50-ML-2-C01-NN	S50-ML-2-C01-PP	S50-MH-2-C01-NN	S50-MH-2-C01-PP	S50-ML-5-C01-NN	S50-ML-5-C01-PP	S50-MH-5-C01-NN	S50-MH-5-C01-PP
<b>Operating distance:</b>																	
axial optics	0 ... 35 cm	•	•			•	•			•	•			•	•		
radial optics	0 ... 25 cm			•	•			•	•			•	•			•	•
<b>Power supply:</b>	10 ... 30 Vdc <sup>1</sup>	•	•	•	•	•	•	•	•	•	•	•	•	•	•	•	•
<b>Ripple:</b>	≤2 Vpp	•	•	•	•	•	•	•	•	•	•	•	•	•	•	•	•
<b>Consumption:</b>	≤35 mA	•	•	•	•	•	•	•	•	•	•	•	•	•	•	•	•
<b>Light emission:</b>	red Laser 650 nm <sup>2</sup>	•	•	•	•	•	•	•	•	•	•	•	•	•	•	•	•
	class I EN 60825-1																
	class II CDRH21 CFR 1040.10																
<b>Resolution:</b>	approx. 0.3 mm at 5 cm	•	•	•	•	•	•	•	•	•	•	•	•	•	•	•	•
	approx. 0.3 mm at 10 cm	•	•	•	•	•	•	•	•	•	•	•	•	•	•	•	•
	approx. 0.5 mm at 20 cm	•	•	•	•	•	•	•	•	•	•	•	•	•	•	•	•
	approx. 2 mm at 30 cm	•	•	•	•	•	•	•	•	•	•	•	•	•	•	•	•
<b>Setting:</b>	sensitivity trimmer	•	•	•	•	•	•	•	•	•	•	•	•	•	•	•	•
<b>Indicators:</b>	yellow OUTPUT LED	•	•	•	•	•	•	•	•	•	•	•	•	•	•	•	•
	green STABILITY LED	•	•	•	•	•	•	•	•	•	•	•	•	•	•	•	•
<b>Output type:</b>	PNP, NO and NC		•		•		•		•		•		•		•		•
	NPN, NO and NC	•		•		•		•		•		•		•		•	
<b>Output current:</b>	≤ 100 mA	•	•	•	•	•	•	•	•	•	•	•	•	•	•	•	•
<b>Saturation voltage:</b>	≤2 V	•	•	•	•	•	•	•	•	•	•	•	•	•	•	•	•
<b>Response time:</b>	333 ms	•	•	•	•	•	•	•	•	•	•	•	•	•	•	•	•
<b>Switching frequency:</b>	1.5 kHz	•	•	•	•	•	•	•	•	•	•	•	•	•	•	•	•
<b>Operating mode:</b>	light on NO / dark on NC	•	•	•	•	•	•	•	•	•	•	•	•	•	•	•	•
<b>Connection:</b>	2 m Ø 4 mm cable <sup>4</sup>	•	•			•	•			•	•			•	•		
	M12 4-pole connector <sup>5</sup>			•	•			•	•			•	•			•	•
<b>Electrical protection:</b>	class 2	•	•	•	•	•	•	•	•	•	•	•	•	•	•	•	•
<b>Mechanical protection:</b>	IP67	•	•	•	•	•	•	•	•	•	•	•	•	•	•	•	•
<b>Protection devices:</b>	A, B <sup>6</sup>	•	•	•	•	•	•	•	•	•	•	•	•	•	•	•	•
<b>Housing material:</b>	PBT	•	•	•	•	•	•	•	•	•	•	•	•	•	•	•	•
	nickel plated brass									•	•	•	•			•	•
<b>Lens material:</b>	PMMA / glass	•	•	•	•	•	•	•	•	•	•	•	•	•	•	•	•
<b>Weight:</b>	75 g max.	•	•	•	•												
	25 g max.					•	•	•	•								
	110 g max.									•	•	•	•				
	60 g max.													•	•	•	•
<b>Operating temperature:</b>	-10 ... +50°C	•	•	•	•	•	•	•	•	•	•	•	•	•	•	•	•
<b>Storage temperature:</b>	-25 ... +70°C	•	•	•	•	•	•	•	•	•	•	•	•	•	•	•	•
<b>Reference standard:</b>	EN 60947-5-2, EN 60825-1	•	•	•	•	•	•	•	•	•	•	•	•	•	•	•	•
	CDRH21 CFR 1040.10	•	•	•	•	•	•	•	•	•	•	•	•	•	•	•	•

**SELECTION TABLE**

plastic - axial optics - 2 m cable		
S50-PL-2-C01-NN	952001880	NPN
S50-PL-2-C01-PP	952001380	PNP
plastic - radial optics - 2 m cable		
S50-PH-2-C01-NN	952001990	NPN
S50-PH-2-C01-PP	952001980	PNP
metal - axial optics - 2 m cable		
S50-ML-2-C01-NN	952021830	NPN
S50-ML-2-C01-PP	952021410	PNP
metal - radial optics - 2 m cable		
S50-MH-2-C01-NN	952021990	NPN
S50-MH-2-C01-PP	952021980	PNP
plastic - axial optics - M12 connector		
S50-PL-5-C01-NN	952001850	NPN
S50-PL-5-C01-PP	952001390	PNP
plastic - radial optics - M12 connector		
S50-PH-5-C01-NN	952002010	NPN
S50-PH-5-C01-PP	952002000	PNP
metal - axial optics - M12 connector		
S50-ML-5-C01-NN	952021860	NPN
S50-ML-5-C01-PP	952021450	PNP
metal - radial optics - M12 connector		
S50-MH-5-C01-NN	952022010	NPN
S50-MH-5-C01-PP	952022000	PNP

All the ordering codes and information are summarised in the last pages of this catalogue.  
**The use of the MICRO-18 fixing bracket (cod. 95ACC1380) is recommended for the correct optic axis alignment of the laser emission.**



\*Only on axial optic models

**DETECTION DIAGRAMS**



■ Operating distance

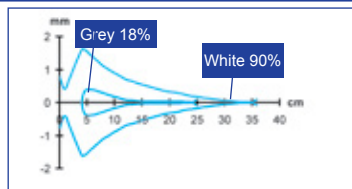

Detection area - axial

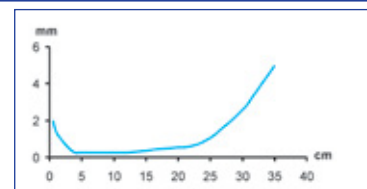

Resolution - axial

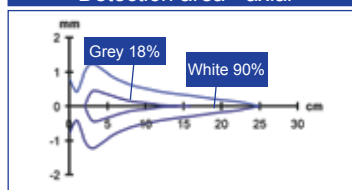

Detection area - radial

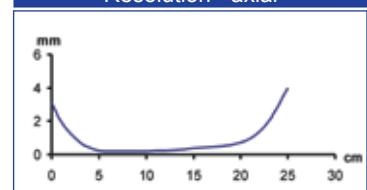

Resolution - radial

## M AXIAL RED EMISSION

Background suppression proximity allows to precisely adjust the distance over which the object is not detected, with the minimum difference between reflective objects. The EASYtouch™ setting procedure fixes automatically the best detection conditions, simply pressing once the teach-in push-button, in presence of the reference to detect.



## DIMENSIONS

### PLASTIC HOUSING

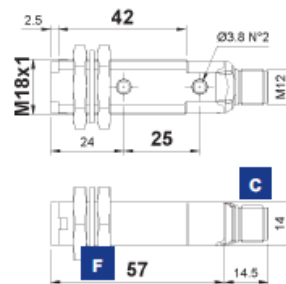

### METAL HOUSING

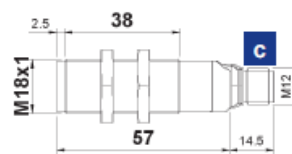

## INDICATORS AND SETTINGS



- A** OUTPUT status and READY/ ERROR LEDs
- B** Teach-in push-button
- C** M12 connector output
- D** Cable output
- E** Fixing nuts
- F** Fixing gasket

Teach-in button for setting.  
EASYtouch™ provides two setting modes: standard or fine, both obtained by pressing the push-button only once. Please refer to instructions manual for operating details.

## ACCESSORIES

For **dedicated accessories** refer to the **ACCESSORIES** section of this catalogue.

Refer also to **Connectors and Fixing brackets of the General Catalogue**.

## CONNECTIONS

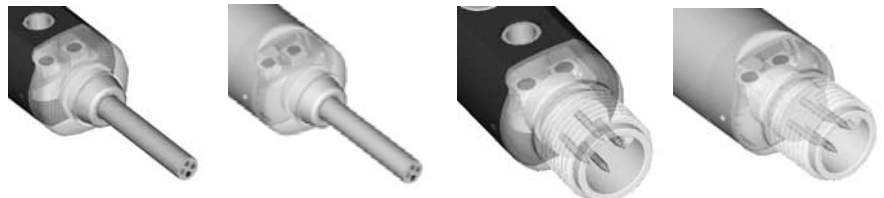

S50-XX-2

S50-XX-5

BROWN 1 + 10 ... 30 Vdc  
 WHITE 2 NC OUTPUT  
 BLACK 4 NO OUTPUT  
 BLUE 3 0 V

NC OUTPUT (WHITE) 2 + 10 ... 30 Vdc (BROWN) 1  
 0 V (BLUE) 3 NO OUTPUT (BLACK) 4

Versions and options: refer to **MODEL ALPHABETICAL INDEX** of this catalogue.

**TECHNICAL DATA**

**TECHNICAL NOTES**

- <sup>1</sup>Limit values
- <sup>2</sup>Average life of 100,000 h with TA = +25 °C
- <sup>3</sup>PVC, 4 x 0.14 mm<sup>2</sup>
- <sup>4</sup>Compatible with quick connection systems
- <sup>5</sup>A - reverse polarity protection
- B - overload and short-circuit protection on receiver outputs

		S50-PA-2-M03-NN	S50-PA-2-M03-PP	S50-PA-5-M03-NN	S50-PA-5-M03-PP	S50-MA-2-M03-NN	S50-MA-2-M03-PP	S50-MA-5-M03-NN	S50-MA-5-M03-PP
<b>Operating distance:</b>	5 ... 10 cm	•	•	•	•	•	•	•	•
<b>Power supply:</b>	10 ... 30 Vdc <sup>1</sup>	•	•	•	•	•	•	•	•
<b>Ripple:</b>	≤ 2 Vpp	•	•	•	•	•	•	•	•
<b>Consumption:</b>	≤30 mA	•	•	•	•	•	•	•	•
<b>Light emission:</b>	red LED 630 nm <sup>2</sup>	•	•	•	•	•	•	•	•
<b>Spot dimension:</b>	teach-in push-button	•	•	•	•	•	•	•	•
<b>Setting:</b>	teach-in EASYtouch™	•	•	•	•	•	•	•	•
<b>Indicators:</b>	yellow OUTPUT LED	•	•	•	•	•	•	•	•
	green / red READY / ERROR LED	•	•	•	•	•	•	•	•
<b>Output type:</b>	PNP, NO and NC		•		•		•		•
	NPN, NO and NC	•		•		•		•	
<b>Output current:</b>	≤100 mA	•	•	•	•	•	•	•	•
<b>Saturation voltage:</b>	≤ 2 V	•	•	•	•	•	•	•	•
<b>Response time:</b>	1 ms	•	•	•	•	•	•	•	•
<b>Switching frequency:</b>	500 Hz	•	•	•	•	•	•	•	•
<b>Operating mode:</b>	dark on NO / light on NC	•	•	•	•	•	•	•	•
<b>Connection:</b>	2 m Ø 4 mm cable <sup>3</sup>	•	•			•	•		
	M12 4-pole connector <sup>4</sup>			•	•			•	•
<b>Electrical protection:</b>	class 2	•	•	•	•	•	•	•	•
<b>Mechanical protection:</b>	IP67	•	•	•	•	•	•	•	•
<b>Protection devices:</b>	A, B <sup>5</sup>	•	•	•	•	•	•	•	•
<b>Housing material:</b>	PBT / PVC	•	•	•	•				
	nickel plated brass					•	•	•	•
<b>Lens material:</b>	glass	•	•	•	•	•	•	•	•
<b>Weight:</b>	90 g max.	•	•						
	40 g max.			•	•				
	125 g max.					•	•		
	75 g max.							•	•
<b>Operating temperature:</b>	-25 ... +55°C	•	•	•	•	•	•	•	•
<b>Storage temperature:</b>	-25 ... +70°C	•	•	•	•	•	•	•	•
<b>Reference standard:</b>	EN 60947-5-2	•	•	•	•	•	•	•	•

**SELECTION TABLE**

plastic - axial optics - 2 m cable		
S50-PA-2-M03-NN	952001670	NPN
S50-PA-2-M03-PP	952001230	PNP

metal - axial optics - 2 m cable		
S50-MA-2-M03-NN	952021550	NPN
S50-MA-2-M03-PP	952021070	PNP

plastic - axial optics - M12 connector		
S50-PA-5-M03-NN	952001560	NPN
S50-PA-5-M03-PP	952001000	PNP

metal - axial optics - M12 connector		
S50-MA-5-M03-NN	952021710	NPN
S50-MA-5-M03-PP	952021270	PNP

All the ordering codes and information are summarised in the last pages of this catalogue.



**DETECTION DIAGRAMS**

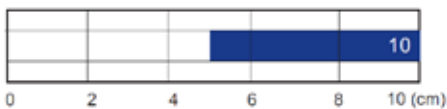

■ Operating distance

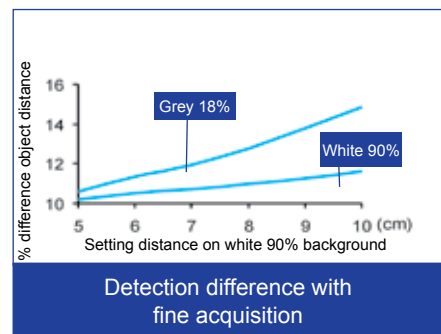
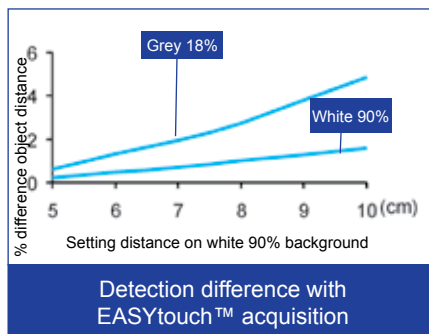

## M RADIAL RED EMISSION

This version of diffuse proximity sensor has a detection distance that can be set using the sensitivity adjustment trimmer. The green stability LED indicates whether the received signal is above to the minimum signal for stable output switching.



## DIMENSIONS

### PLASTIC HOUSING

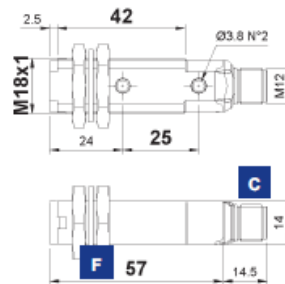

### METAL HOUSING

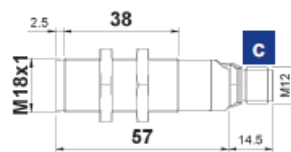

## INDICATORS AND SETTINGS

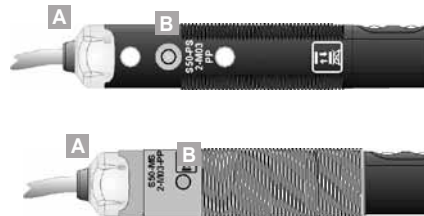

- A** OUTPUT status and READY/ ERROR LEDs
- B** Teach-in push-button
- C** M12 connector output
- D** Cable output
- E** Fixing nuts
- F** Fixing gasket

Teach-in button for setting.  
EASYtouch™ provides two setting modes: standard or fine, both obtained by pressing the push-button only once. Please refer to instructions manual for operating details.

## ACCESSORIES

For **dedicated accessories** refer to the **ACCESSORIES** section of this catalogue.

Refer also to **Connectors and Fixing brackets of the General Catalogue**.

## CONNECTIONS

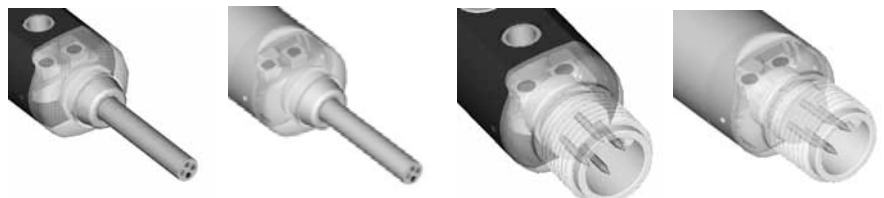

S50-XX-2

S50-XX-5

BROWN 1 + 10 ... 30 Vdc  
 WHITE 2 NC OUTPUT  
 BLACK 4 NO OUTPUT  
 BLUE 3 0 V

NC OUTPUT (WHITE) 2 + 10 ... 30 Vdc (BROWN) 1  
 0 V (BLUE) 3 NO OUTPUT (BLACK) 4

Versions and options: refer to **MODEL ALPHABETICAL INDEX** of this catalogue.

**TECHNICAL DATA**

**TECHNICAL NOTES**

- <sup>1</sup>Limit values
- <sup>2</sup>Average life of 100.000 h with TA = +25 °C
- <sup>3</sup>PVC, 4 x 0.14 mm<sup>2</sup>
- <sup>4</sup>Compatible with quick connection systems
- <sup>5</sup>A - reverse polarity protection
- B - overload and short-circuit protection on receiver outputs

		S50-PS-2-M03-NN	S50-PS-2-M03-PP	S50-PS-5-M03-NN	S50-PS-5-M03-PP	S50-MS-2-M03-NN	S50-MS-2-M03-PP	S50-MS-5-M03-NN	S50-MS-5-M03-PP
<b>Operating distance:</b>	5 ... 10 cm	•	•	•	•	•	•	•	•
<b>Power supply:</b>	10 ... 30 Vdc <sup>1</sup>	•	•	•	•	•	•	•	•
<b>Ripple:</b>	≤ 2 Vpp	•	•	•	•	•	•	•	•
<b>Consumption:</b>	≤30 mA	•	•	•	•	•	•	•	•
<b>Light emission:</b>	red LED 630 nm <sup>2</sup>	•	•	•	•	•	•	•	•
<b>Spot dimension:</b>	approx. 10 mm at 10 cm	•	•	•	•	•	•	•	•
<b>Setting:</b>	teach-in push-button	•	•	•	•	•	•	•	•
<b>Setting procedure:</b>	teach-in EASYtouch™	•	•	•	•	•	•	•	•
<b>Indicators:</b>	yellow OUTPUT LED	•	•	•	•	•	•	•	•
	green / red READY / ERROR LED	•	•	•	•	•	•	•	•
<b>Output type:</b>	PNP, NO and NC	•	•	•	•	•	•	•	•
	NPN, NO and NC	•	•	•	•	•	•	•	•
<b>Output current:</b>	≤100 mA	•	•	•	•	•	•	•	•
<b>Saturation voltage:</b>	≤ 2 V	•	•	•	•	•	•	•	•
<b>Response time:</b>	1 ms	•	•	•	•	•	•	•	•
<b>Switching frequency:</b>	500 Hz	•	•	•	•	•	•	•	•
<b>Operating mode:</b>	dark on NO / light on NC	•	•	•	•	•	•	•	•
<b>Connection:</b>	2 m Ø 4 mm cable <sup>3</sup>	•	•	•	•	•	•	•	•
	M12 4-pole connector <sup>4</sup>	•	•	•	•	•	•	•	•
<b>Electrical protection:</b>	class 2	•	•	•	•	•	•	•	•
<b>Mechanical protection:</b>	IP67	•	•	•	•	•	•	•	•
<b>Protection devices:</b>	A, B <sup>5</sup>	•	•	•	•	•	•	•	•
<b>Housing material:</b>	PBT / PVC	•	•	•	•	•	•	•	•
	nickel plated brass	•	•	•	•	•	•	•	•
<b>Lens material:</b>	glass	•	•	•	•	•	•	•	•
<b>Weight:</b>	90 g max.	•	•	•	•	•	•	•	•
	40 g max.	•	•	•	•	•	•	•	•
	125 g max.	•	•	•	•	•	•	•	•
	75 g max.	•	•	•	•	•	•	•	•
<b>Operating temperature:</b>	-25 ... +55 °C	•	•	•	•	•	•	•	•
<b>Storage temperature:</b>	-25 ... +70 °C	•	•	•	•	•	•	•	•
<b>Reference standard:</b>	EN 60947-5-2	•	•	•	•	•	•	•	•

**SELECTION TABLE**

plastic - 2 m cable		
S50-PS-2-M03-NN	952001900	NPN
S50-PS-2-M03-PP	952001910	PNP

metal - 2 m cable		
S50-MS-2-M03-NN	952021900	NPN
S50-MS-2-M03-PP	952021910	PNP

plastic - M12 connector		
S50-PS-5-M03-NN	952001920	NPN
S50-PS-5-M03-PP	952001930	PNP

metal - M12 connector		
S50-MS-5-M03-NN	952021920	NPN
S50-MS-5-M03-PP	952021930	PNP

All the ordering codes and information are summarised in the last pages of this catalogue.



**DETECTION DIAGRAMS**

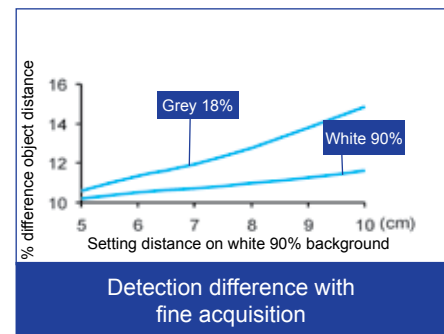
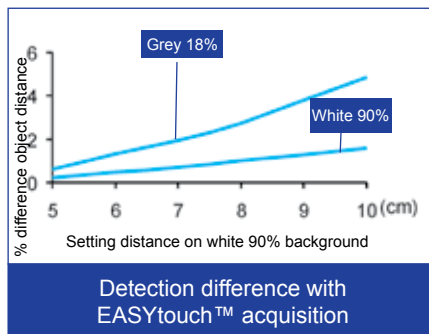
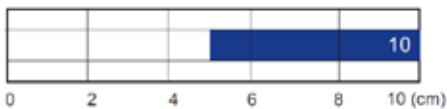

## E RED EMISSION

The amplifier is built to accept any standard 2.2 mm Ø fibre-optic which can be for either diffused or through beam operation. A locking ring when tightened holds the fibres firmly in position. The sensitivity is adjusted by an IP67 rated trimmer. The proximity or through beam fibres are mainly used in applications where space is of a premium and for detection of small objects. Special fibres are also available for high temperature and high wear applications. For further information on the extensive range of fibre-optic accessories please see the OF datasheet.



## DIMENSIONS

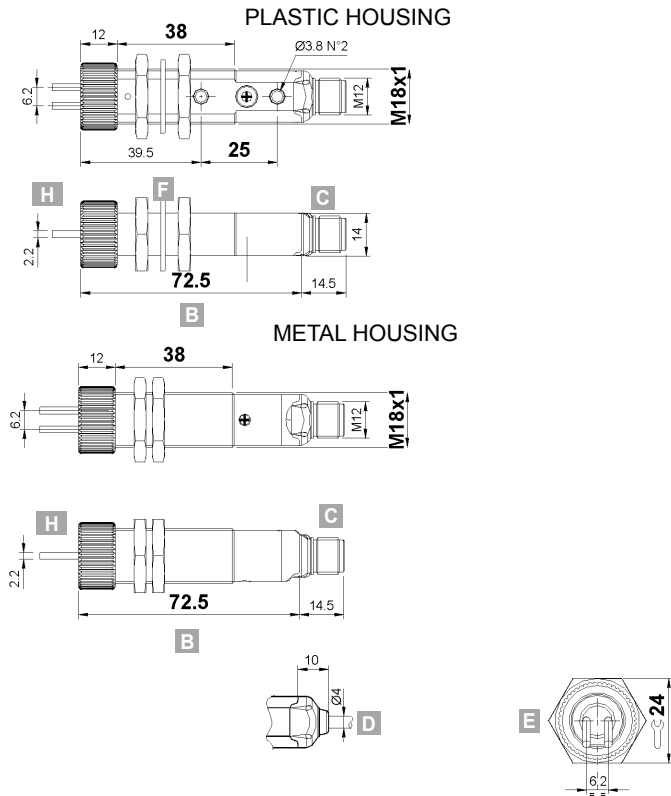

## INDICATORS AND SETTINGS

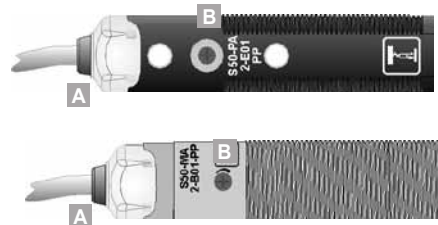

- A** OUTPUT status and STABILITY LEDs
- B** Adjustment trimmer
- C** M12 connector output
- D** Cable output
- E** Fixing nuts
- F** Fixing gasket
- H** Fibre fixing nut

Single-turn trimmer for sensitivity adjustment. Rotate in a clockwise direction to increase the operating distance.

## ACCESSORIES

For **dedicated accessories** refer to the **ACCESSORIES** section of this catalogue.

Refer also to **Connectors and Fixing brackets** of the **General Catalogue**.

## CONNECTIONS

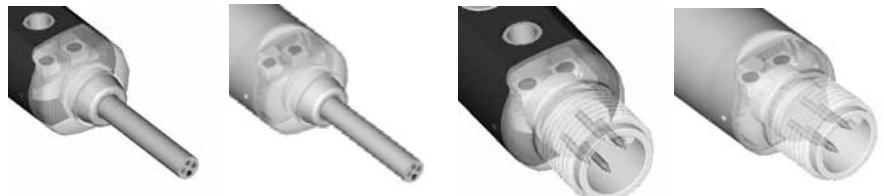

S50-XX-2

S50-XX-5

BROWN	1	+	10 ... 30 Vdc
WHITE	2		NC OUTPUT
BLACK	4		NO OUTPUT
BLUE	3	-	0 V

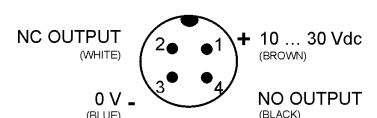

Versions and options: refer to **MODEL ALPHABETICAL INDEX** of this catalogue.



**TECHNICAL DATA**

**TECHNICAL NOTES**

- <sup>1</sup>Limit values
- <sup>2</sup>Average life of 100.000 h with T<sub>A</sub> = +25 °C
- <sup>3</sup>270° single-turn trimmer
- <sup>4</sup>PVC, 4 x 0.14 mm<sup>2</sup>
- <sup>5</sup>Compatible with quick connection systems
- <sup>6</sup>A - reverse polarity protection
- B - overload and short-circuit protection on receiver outputs

		S50-PA-2-E01-NN	S50-PA-2-E01-PP	S50-PA-5-E01-NN	S50-PA-5-E01-PP	S50-MA-2-E01-NN	S50-MA-2-E01-PP	S50-MA-5-E01-NN	S50-MA-5-E01-PP
<b>Operating distance:</b>									
proximity	3 cm (OF-42-ST-20 standard fibres)	•	•	•	•	•	•	•	•
through beam	10 cm (OF-43-ST-20 standard fibres)	•	•	•	•	•	•	•	•
<b>Power supply:</b>	10 ... 30 Vdc <sup>1</sup>	•	•	•	•	•	•	•	•
<b>Ripple:</b>	≤ 2 Vpp	•	•	•	•	•	•	•	•
<b>Consumption:</b>	≤ 35 mA	•	•	•	•	•	•	•	•
<b>Light emission:</b>	red LED 660 nm <sup>2</sup>	•	•	•	•	•	•	•	•
<b>Setting:</b>	sensitivity trimmer <sup>3</sup>	•	•	•	•	•	•	•	•
<b>Indicators:</b>	yellow OUTPUT LED	•	•	•	•	•	•	•	•
	green STABILITY	•	•	•	•	•	•	•	•
<b>Output type:</b>	PNP, NO and NC	•	•	•	•	•	•	•	•
	NPN, NO and NC	•	•	•	•	•	•	•	•
<b>Output current:</b>	≤ 100 mA	•	•	•	•	•	•	•	•
<b>Saturation voltage:</b>	≤ 2 V	•	•	•	•	•	•	•	•
<b>Response time:</b>	0.5 ms	•	•	•	•	•	•	•	•
<b>Switching frequency:</b>	1 kHz	•	•	•	•	•	•	•	•
<b>Operating mode:</b>	dark on NO / light on NC	•	•	•	•	•	•	•	•
<b>Connection:</b>	2 m Ø 4 mm cable <sup>4</sup>	•	•			•	•		
	M12 4-pole connector <sup>5</sup>			•	•			•	•
<b>Electrical protection:</b>	class 2	•	•	•	•	•	•	•	•
<b>Mechanical protection:</b>	IP67	•	•	•	•	•	•	•	•
<b>Protection devices:</b>	A, B <sup>6</sup>	•	•	•	•	•	•	•	•
<b>Housing material:</b>	PBT	•	•	•	•				
	nickel plated brass					•	•	•	•
<b>Fibre fixing nut material:</b>	ABS	•	•	•	•	•	•	•	•
<b>Weight:</b>	75 g max.	•	•						
	25 g max.			•	•				
	110 g max.					•	•		
	60 g max.							•	•
<b>Operating temperature:</b>	-25 ... +55 °C	•	•	•	•	•	•	•	•
<b>Storage temperature:</b>	-25 ... +70 °C	•	•	•	•	•	•	•	•
<b>Reference standard:</b>	EN 60947-5-2	•	•	•	•	•	•	•	•

**SELECTION TABLE**

plastic - axial optics - 2 m cable		
S50-PA-2-E01-NN	952001650	NPN
S50-PA-2-E01-PP	952001130	PNP

metal - axial optics - 2 m cable		
S50-MA-2-E01-NN	952021880	NPN
S50-MA-2-E01-PP	952021040	PNP

plastic - axial optics - M12 connector		
S50-PA-5-E01-NN	952001540	NPN
S50-PA-5-E01-PP	952001140	PNP

metal - axial optics - M12 connector		
S50-MA-5-E01-NN	952021890	NPN
S50-MA-5-E01-PP	952021240	PNP

All the ordering codes and information are summarised in the last pages of this catalogue.



**DETECTION DIAGRAMS**

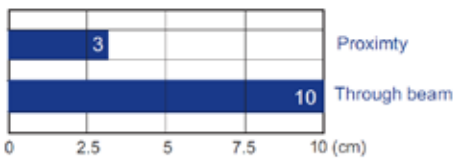

■ Operating distance with standard fibres

*Standard fibre-optics:*  
 OF-42-ST-20 proximity  
 OF-43-ST-20 through beam

High efficiency fibre-optics or accessory lenses can be used to obtain larger operating distances. Refer to **Fibre-optics** of the **General Catalogue**

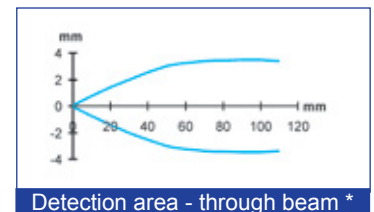
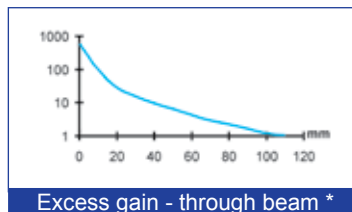
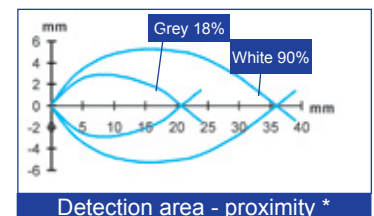
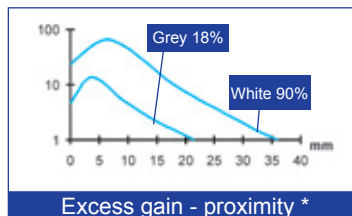

\* standard fibre-optics

## W WHITE EMISSION

The white light LED emission is designed for the detection of a large number of coloured or grey-scale contrasts, in order to detect print registration marks or similar. The EASYtouch™ setting procedures automatically selects the best detection conditions, simply by pressing the teach-in push-button once, in the presence of a reference mark. By pressing the teach-in push-button and holding it down until the green light on the rear of the sensor flashes, in the presence of the reference mark and then pressing the button again in the presence of the contrast you wish to ignore, a higher level of accuracy is obtained.



## DIMENSIONS

### PLASTIC HOUSING

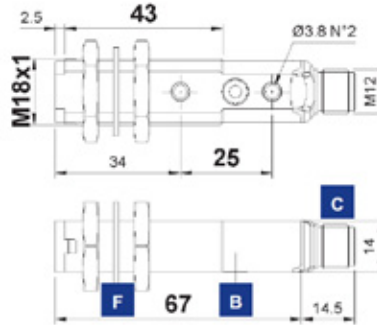

### METAL HOUSING

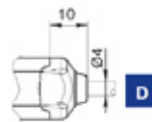
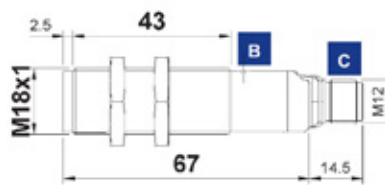

mm

## INDICATORS AND SETTINGS

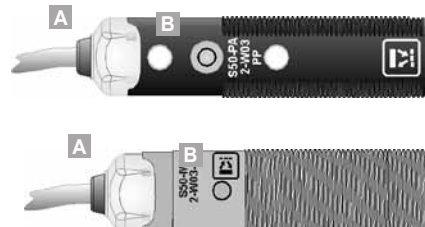

- A** OUTPUT status and READY/ ERROR LEDs
- B** Teach-in push-button
- C** M12 connector output
- D** Cable output
- E** Fixing nuts
- F** Fixing gasket

Teach-in button for setting.

EASYtouch™ provides two setting modes: standard or fine, both obtained by pressing the push-button only once. Please refer to instructions manual for operating details.

## ACCESSORIES

For **dedicated accessories** refer to the **ACCESSORIES** section of this catalogue.

Refer also to **Connectors and Fixing brackets of the General Catalogue**.

## CONNECTIONS



S50-XX-2



S50-XX-5



BROWN	1	+	10 ... 30 Vdc
WHITE	2		NC OUTPUT
BLACK	4		NO OUTPUT
BLUE	3	-	0 V

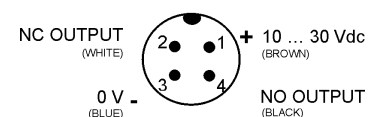

Versions and options: refer to **MODEL ALPHABETICAL INDEX** of this catalogue.

**TECHNICAL DATA**

TECHNICAL NOTES		S50-PA-2-W03-NN	S50-PA-2-W03-PP	S50-PA-5-W03-NN	S50-PA-5-W03-PP	S50-MA-2-W03-NN	S50-MA-2-W03-PP	S50-MA-5-W03-NN	S50-MA-5-W03-PP
<b>Operating distance:</b>		10 mm	•	•	•	•	•	•	•
<b>Depth of field (max.):</b>		± 2 mm	•	•	•	•	•	•	•
<b>Power supply:</b>		10 ... 30 Vdc <sup>1</sup>	•	•	•	•	•	•	•
<b>Ripple:</b>		≤ 2 Vpp	•	•	•	•	•	•	•
<b>Consumption:</b>		≤ 25 mA	•	•	•	•	•	•	•
<b>Light emission:</b>		white LED 400 - 700 nm <sup>2</sup>	•	•	•	•	•	•	•
<b>Spot dimension:</b>		approx. 4.5 mm at 10 mm	•	•	•	•	•	•	•
<b>Minimum detectable object:</b>		0.5 mm	•	•	•	•	•	•	•
<b>Setting:</b>		teach-in push-button	•	•	•	•	•	•	•
<b>Setting procedure:</b>		teach-in EASYtouch™	•	•	•	•	•	•	•
<b>Indicators:</b>		yellow OUTPUT LED	•	•	•	•	•	•	•
		green / red READY / ERROR LED	•	•	•	•	•	•	•
<b>Output type:</b>		PNP, NO and NC	•	•	•	•	•	•	•
		NPN, NO and NC	•	•	•	•	•	•	•
<b>Output current:</b>		≤ 100 mA	•	•	•	•	•	•	•
<b>Saturation voltage:</b>		≤ 2 V	•	•	•	•	•	•	•
<b>Response time:</b>		100 ms	•	•	•	•	•	•	•
<b>Switching frequency:</b>		5 kHz	•	•	•	•	•	•	•
<b>Operating mode:</b>		dark with EASYtouch™	•	•	•	•	•	•	•
		automatic dark / light with fine acq.	•	•	•	•	•	•	•
<b>Connection:</b>		2 m Ø 4 mm cable <sup>3</sup>	•	•	•	•	•	•	•
		M12 4-pole connector <sup>4</sup>	•	•	•	•	•	•	•
<b>Electrical protection:</b>		class 2	•	•	•	•	•	•	•
<b>Mechanical protection:</b>		IP67	•	•	•	•	•	•	•
<b>Protection devices:</b>		A, B	•	•	•	•	•	•	•
<b>Housing material:</b>		PBT	•	•	•	•	•	•	•
		nickel plated brass	•	•	•	•	•	•	•
<b>Lens material:</b>		PMMA	•	•	•	•	•	•	•
<b>Weight:</b>		75 g max.	•	•	•	•	•	•	•
		25 g max.			•	•			
		110 g max.				•	•		
		60 g max.					•	•	
<b>Operating temperature:</b>		-25 ... +55°C	•	•	•	•	•	•	•
<b>Storage temperature:</b>		-25 ... +70°C	•	•	•	•	•	•	•
<b>Reference standard:</b>		EN 60947-5-2	•	•	•	•	•	•	•

**SELECTION TABLE**

plastic - axial optics - 2 m cable		
S50-PA-2-W03-NN	952001710	NPN
S50-PA-2-W03-PP	952001320	PNP
metal - axial optics - 2 m cable		
S50-MA-2-W03-NN	952021590	NPN
S50-MA-2-W03-PP	952021110	PNP
plastic - axial optics - M12 connector		
S50-PA-5-W03-NN	952001600	NPN
S50-PA-5-W03-PP	952001330	PNP
metal - axial optics - M12 connector		
S50-MA-5-W03-NN	952021750	NPN
S50-MA-5-W03-PP	952021310	PNP

All the ordering codes and information are summarised in the last pages of this catalogue.



**DETECTION DIAGRAMS**

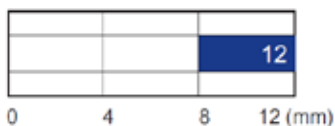

Operating distance

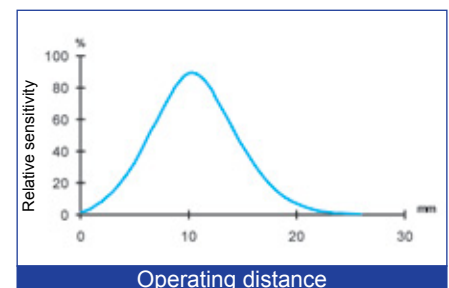

## U UV EMISSION

The UV light LED emission detects any luminescent reference, even on very reflective surfaces, such as ceramics, metal or mirrored glass. The EASYtouch™ setting procedures fixes automatically the best detection conditions, simply by pressing the teach-in push-button once, with the luminescent object present. By pressing the teach-in push-button and holding it down until the green light on the rear of the sensor flashes, with the luminescent object present and then pressing the button again in the presence of a luminescent reference you wish to ignore, a higher level of accuracy is obtained.



## DIMENSIONS

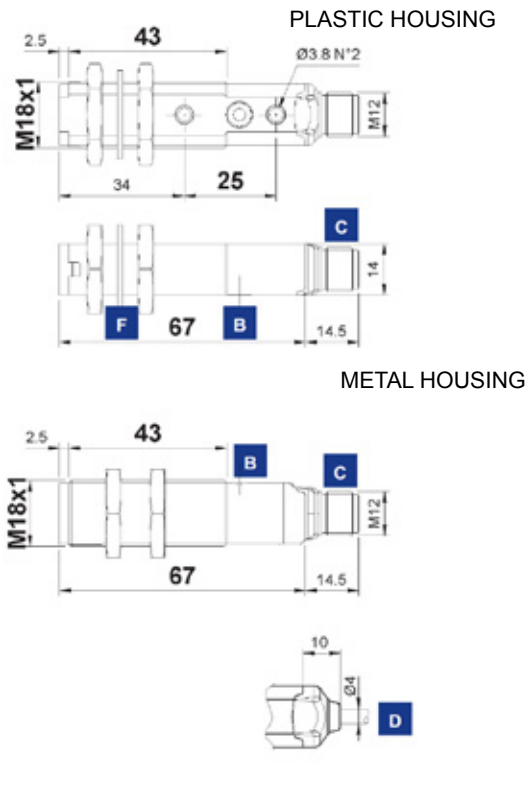

## INDICATORS AND SETTINGS

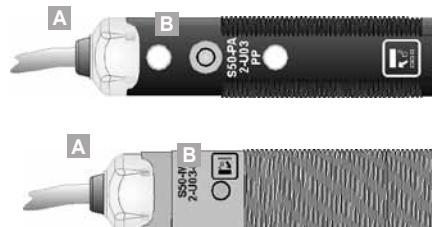

- A** OUTPUT status and READY/ ERROR LEDs
- B** Teach-in push-button
- C** M12 connector output
- D** Cable output
- E** Fixing nuts
- F** Fixing gasket

Teach-in button for setting.

EASYtouch™ provides two setting modes: standard or fine, both obtained by pressing the push-button only once. Please refer to instructions manual for operating details.

## ACCESSORIES

For dedicated accessories refer to the **ACCESSORIES** section of this catalogue.

Refer also to **Connectors and Fixing brackets of the General Catalogue.**

## CONNECTIONS

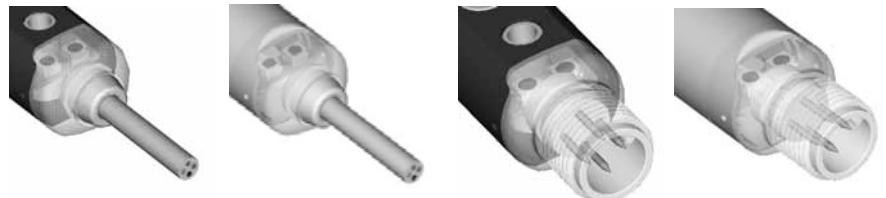

S50-XX-2

S50-XX-5

BROWN	1	+	10 ... 30 Vdc
WHITE	2		NC OUTPUT
BLACK	4		NO OUTPUT
BLUE	3	-	0 V

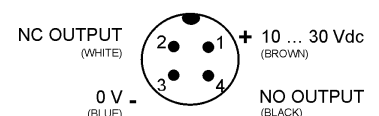

Versions and options: refer to **MODEL ALPHABETICAL INDEX** of this catalogue.

**TECHNICAL DATA**

TECHNICAL NOTES		S50-PA-2-U03-NN	S50-PA-2-U03-PP	S50-PA-5-U03-NN	S50-PA-5-U03-PP	S50-MA-2-U03-NN	S50-MA-2-U03-PP	S50-MA-5-U03-NN	S50-MA-5-U03-PP
<b>Limit values</b>									
<sup>2</sup> Average life of 100.000 h with TA = +25 °C									
<sup>3</sup> PVC, 4 x 0.14 mm <sup>2</sup>									
<sup>4</sup> Compatible with quick connection systems									
<sup>5</sup> A - reverse polarity protection									
B - overload and short-circuit protection on receiver outputs									
<b>Operating distance:</b>	8 ... 20 mm	•	•	•	•	•	•	•	•
<b>Power supply:</b>	10 ... 30 Vdc <sup>1</sup>	•	•	•	•	•	•	•	•
<b>Ripple:</b>	≤ 2 Vpp	•	•	•	•	•	•	•	•
<b>Consumption:</b>	≤ 25 mA	•	•	•	•	•	•	•	•
<b>Light emission:</b>	UV LED 370 nm <sup>2</sup>	•	•	•	•	•	•	•	•
<b>Spot dimension:</b>	approx. 3 mm at 20 mm	•	•	•	•	•	•	•	•
<b>Minimum detectable object:</b>	0.5 mm	•	•	•	•	•	•	•	•
<b>Setting:</b>	teach-in push-button	•	•	•	•	•	•	•	•
<b>Setting procedure:</b>	teach-in EASYtouch™	•	•	•	•	•	•	•	•
<b>Indicators:</b>	yellow OUTPUT LED	•	•	•	•	•	•	•	•
	green / red READY / ERROR LED	•	•	•	•	•	•	•	•
<b>Output type:</b>	PNP, NO and NC	•	•	•	•	•	•	•	•
	NPN, NO and NC	•	•	•	•	•	•	•	•
<b>Output current:</b>	≤ 100 mA	•	•	•	•	•	•	•	•
<b>Saturation voltage:</b>	≤ 2 V	•	•	•	•	•	•	•	•
<b>Response time:</b>	500 ms	•	•	•	•	•	•	•	•
<b>Switching frequency:</b>	1 kHz	•	•	•	•	•	•	•	•
<b>Operating mode:</b>	dark with EASYtouch™	•	•	•	•	•	•	•	•
	automatic dark / light with fine acq.	•	•	•	•	•	•	•	•
<b>Connection:</b>	2 m Ø 4 mm cable <sup>3</sup>	•	•	•	•	•	•	•	•
	M12 4-pole connector <sup>4</sup>	•	•	•	•	•	•	•	•
<b>Electrical protection:</b>	class 2	•	•	•	•	•	•	•	•
<b>Mechanical protection:</b>	IP67	•	•	•	•	•	•	•	•
<b>Protection devices:</b>	A, B <sup>5</sup>	•	•	•	•	•	•	•	•
<b>Housing material:</b>	PBT	•	•	•	•	•	•	•	•
	nickel plated brass	•	•	•	•	•	•	•	•
<b>Lens material:</b>	PMMA	•	•	•	•	•	•	•	•
<b>Weight:</b>	75 g max.	•	•	•	•	•	•	•	•
	25 g max.			•	•				
	110 g max.					•	•		
	60 g max.							•	•
<b>Operating temperature:</b>	-25 ... +55 °C	•	•	•	•	•	•	•	•
<b>Storage temperature:</b>	-25 ... +70 °C	•	•	•	•	•	•	•	•
<b>Reference standard:</b>	EN 60947-5-2	•	•	•	•	•	•	•	•

**SELECTION TABLE**

plastic - axial optics - 2 m cable		
S50-PA-2-U03-NN	952001700	NPN
S50-PA-2-U03-PP	952001300	PNP
metal - axial optics - 2 m cable		
S50-MA-2-U03-NN	952021580	NPN
S50-MA-2-U03-PP	952021100	PNP
plastic - axial optics - M12 connector		
S50-PA-5-U03-NN	952001590	NPN
S50-PA-5-U03-PP	952001310	PNP
metal - axial optics - M12 connector		
S50-MA-5-U03-NN	952021740	NPN
S50-MA-5-U03-PP	952021300	PNP

All the ordering codes and information are summarised in the last pages of this catalogue.



**DETECTION DIAGRAMS**

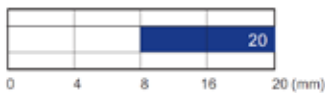

■ Operating distance

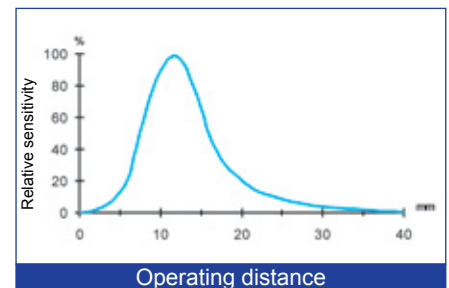

## TECHNOLOGY

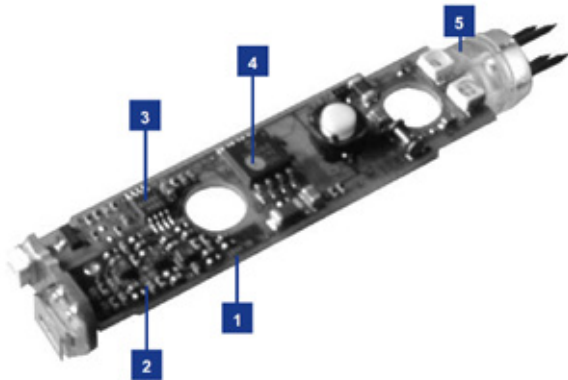

- 1 Multi-layer fine-line PCB
- 2 Chip-size components, integrated circuits in 8 bumps flip-chip
- 3 Analogue digital ASIC
- 4 Power ASIC for antivalent outputs
- 5 M12 custom connector compatible with quick connection systems. The four terminals are cone-shaped to facilitate the direct insertion in the cable conductors (4 x 0,5 mm<sup>2</sup>)

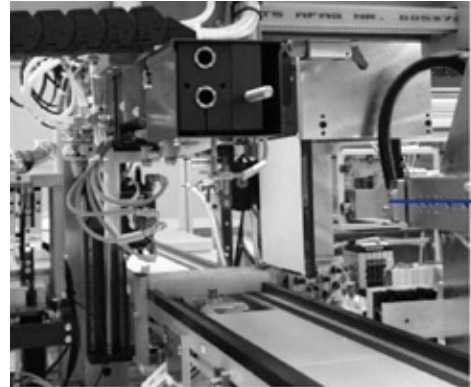

- 6 Housing and fixing nuts in indeformable plastic providing excellent resistance against hostile environments. Indelible laser marking
- 7 A modular product developed for the automation of the assembling and testing process necessary to guarantee intrinsic quality, repeatability and reliability. One-piece-flow management for improved service



EASYtouch™ is a Datasensor patent-covered technology that allows a rapid and safe setting of micro-controlled sensors equipped with a teach-in push-button. A pressure longer than two seconds of the push-button allows a good adjustment of the sensitivity threshold. EASYtouch™ is the easiest and fastest calibration procedure available on the market. The instructions on how to best use EASYtouch™ are given in the product's instruction manual.

## ACCESSORIES

The series is compatible with all the **Datalogic Automation** accessories already developed for tubular sensors. In the **General Catalogue** refer to:

- **CS** connectors
- **R** reflectors
- **OF** fibre-optics
- **ST** fixing brackets

New accessories dedicated to the **S50** series have been developed to cover all the fixing requirements and to improve the functioning. In particular **EASYin™** is an innovative fixing system that can be used only for the plastic flat version, that allows a fast and safe positioning of the sensor, facilitating the adjustment as well as the locking and unlocking.



## ACCESSORY SELECTION AND ORDER INFORMATION

MODEL	DESCRIPTION	ORDER N°
ST-5010	M18/14 fixing bracket	95ACC5230
ST-5011	M18 fixing bracket	95ACC5240
ST-5012	M18 fixing bracket	95ACC5250
ST-5017	M18 fixing bracket	95ACC5270
S50 EASY-IN	M18/14 EASYin™ adjustable fixing support	95ACC5300
JOINT-18	M18 jointed support	95ACC5220
SWING-18	adjustable support for plastic tubular M18 sensors	895000006
MICRO-18	support with micrometric regulation for tubular M18 sensors	95ACC1380
SP-40	fixed support for tubular M18 sensors	95ACC1370
MEK-PROOF	front protection	G5000001

Refer also to **Accessories** for Sensors of the **General Catalogue**

**DIMENSION ACCESSORIES**

**S50 EASYin™**

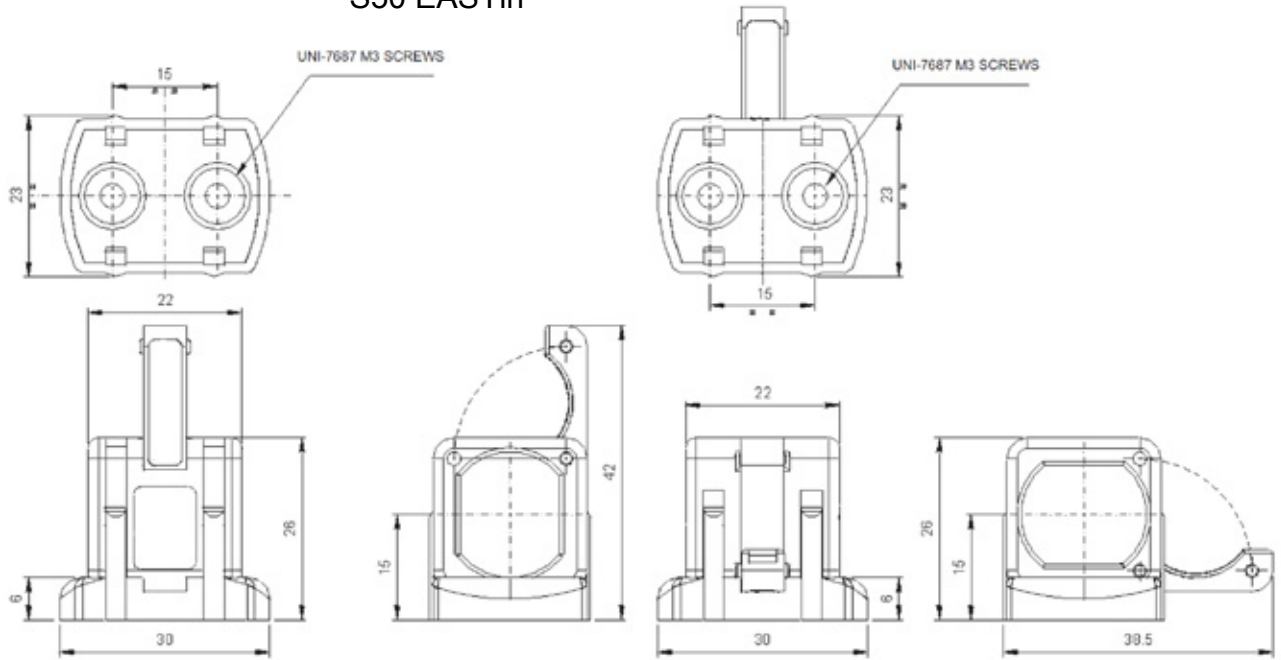

VERTICAL OPTIC AXIS

HORIZONTAL OPTIC AXIS

**JOINT-18**

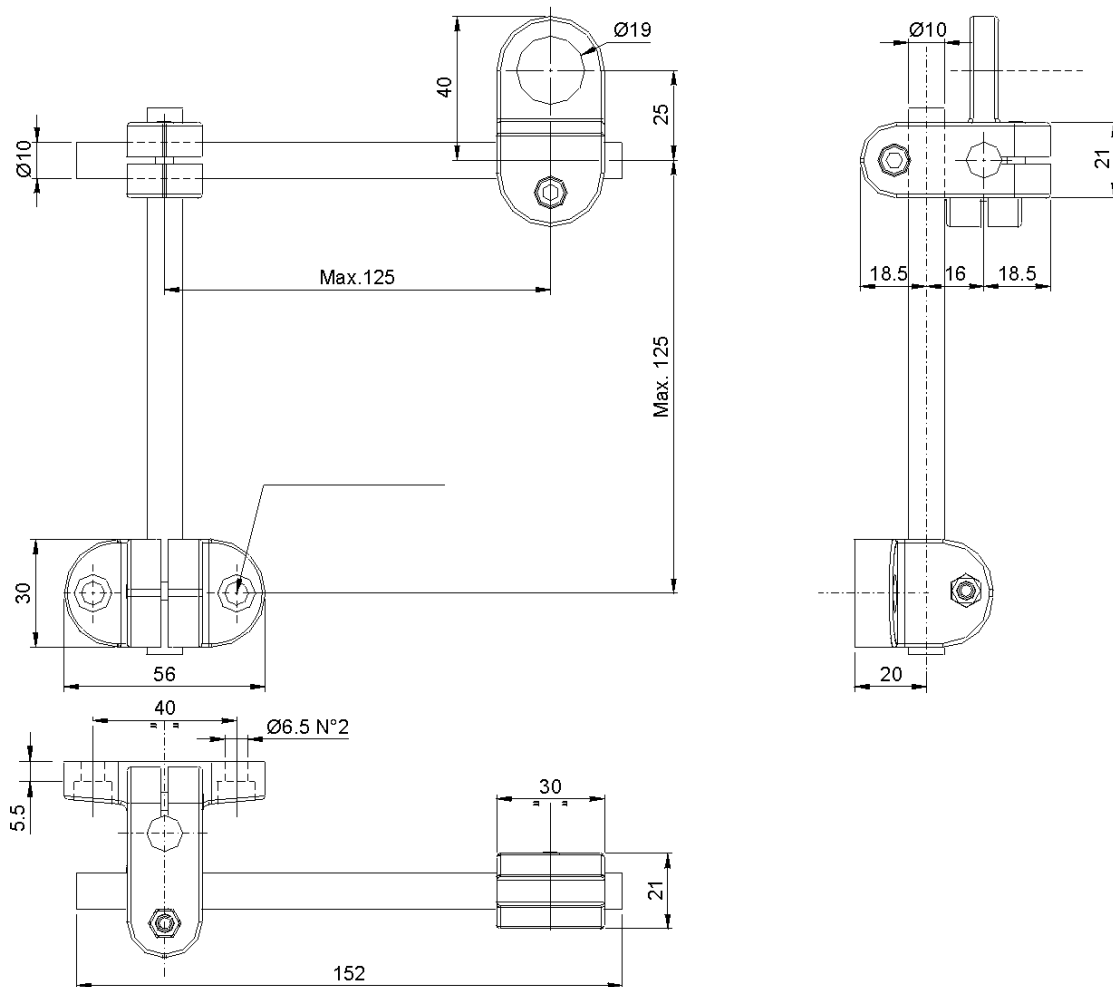

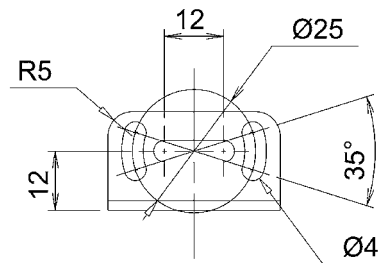
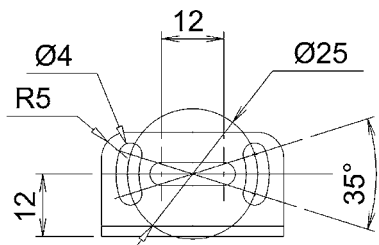
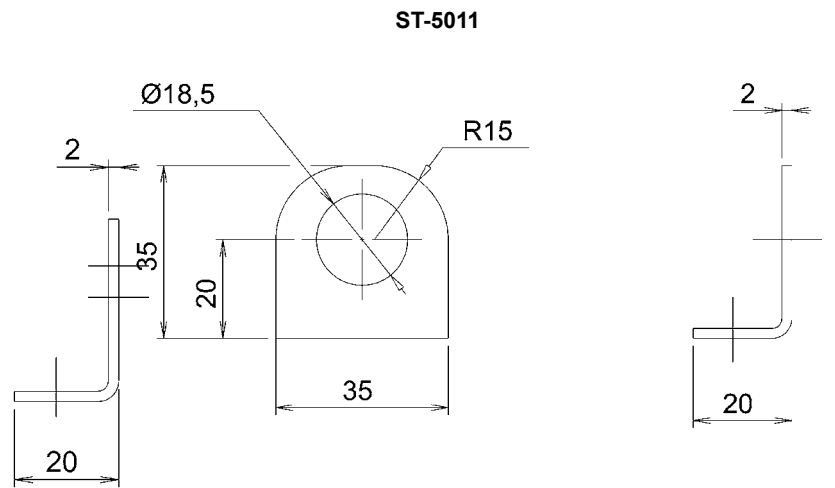
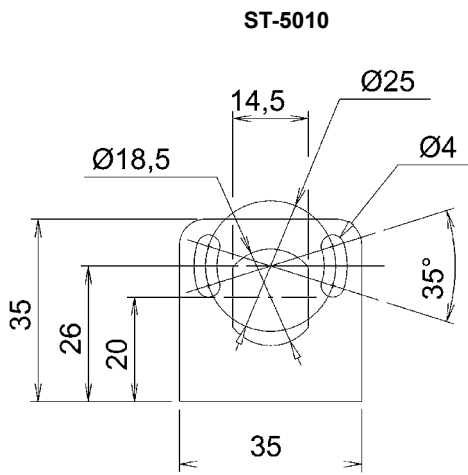

**ST-5012**

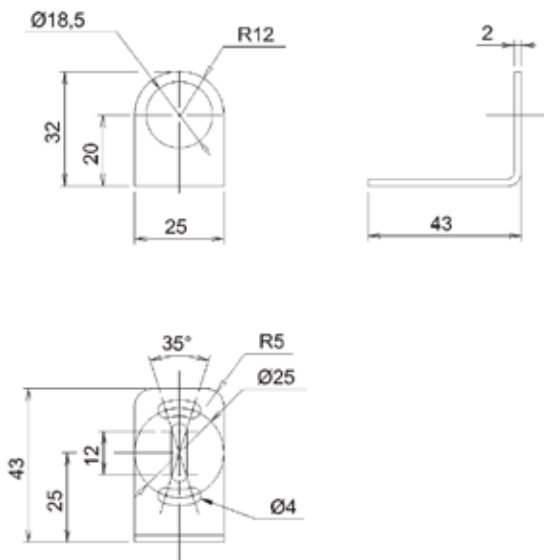

**ST-5017**

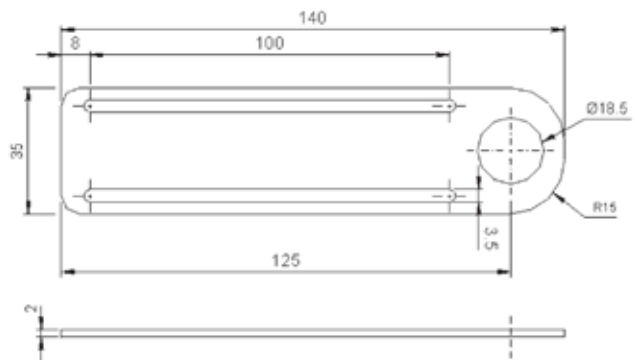



**MICRO-18**

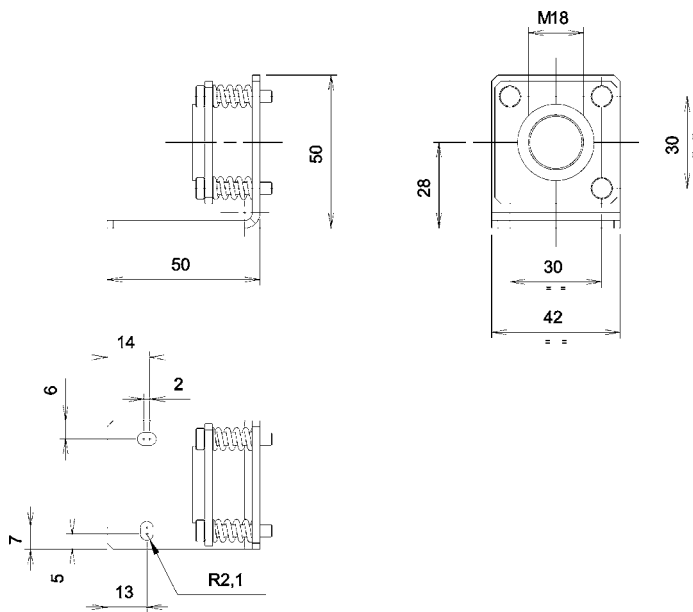

**SWING-18**

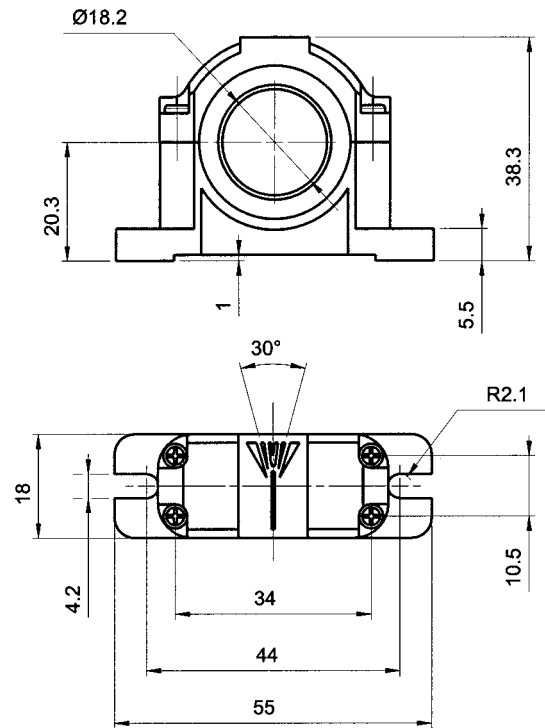

**SP-40**

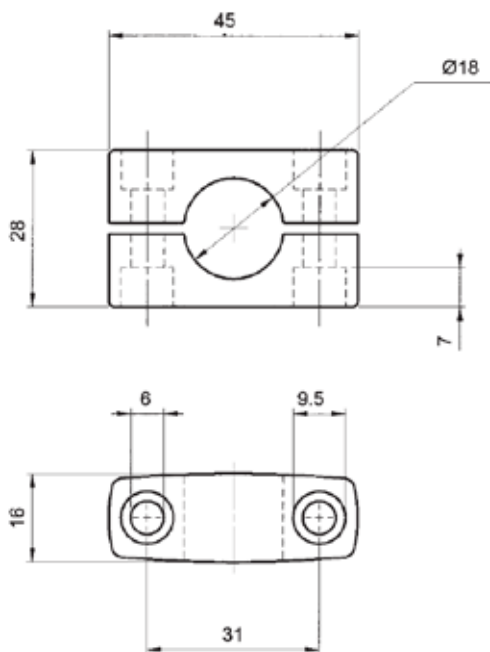

**MEK PROOF**

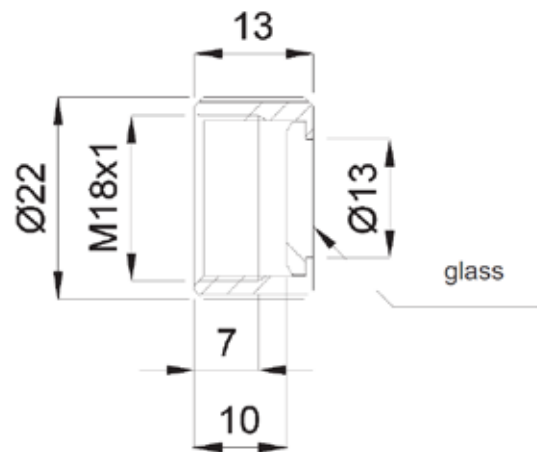

## MODEL SELECTION AND ORDER INFORMATION

PLASTIC FLAT HOUSING WITH AXIAL OPTICS			
MODEL	CODE N°	OPTIC FUNCTION	PAGE
S50-PA-2-A00-NN	952002090	retroreflex	10
S50-PA-2-A00-PP	952002080	retroreflex	10
S50-PA-2-B01-NN	952001610	polarised retroreflex	12
S50-PA-2-B01-PP	952001010	polarised retroreflex	12
S50-PA-2-C01-NN	952001620	long diffuse proximity	22
S50-PA-2-C01-PP	952001050	long diffuse proximity	22
S50-PA-2-C10-NN	952001630	short diffuse proximity	18
S50-PA-2-C10-PP	952001240	short diffuse proximity	18
S50-PA-2-C21-NN	952002170	midi diffuse proximity	20
S50-PA-2-C21-PP	952002160	midi diffuse proximity	20
S50-PA-2-D00-NN	952001640	fixed focus proximity	24
S50-PA-2-D00-PP	952001090	fixed focus proximity	24
S50-PA-2-E01-NN	952001650	fibre-optic amplifier	34
S50-PA-2-E01-PP	952001130	fibre-optic amplifier	34
S50-PA-2-F01-NN	952001660	receiver	2
S50-PA-2-F01-PP	952001150	receiver	2
S50-PA-2-G00-XG	952001190	emitter	2
S50-PA-2-M03-NN	952001670	background suppression	28
S50-PA-2-M03-PP	952001230	background suppression	28
S50-PA-2-T01-NN	952001690	retroreflex for transparents	16
S50-PA-2-T01-PP	952001260	retroreflex for transparents	16
S50-PA-2-U03-NN	952001700	luminescence sensor	38
S50-PA-2-U03-PP	952001300	luminescence sensor	38
S50-PA-2-W03-NN	952001710	contrast sensor	36
S50-PA-2-W03-PP	952001320	contrast sensor	36
S50-PA-5-A00-NN	952002110	retroreflex	10
S50-PA-5-A00-PP	952002100	retroreflex	10
S50-PA-5-B01-NN	952001500	polarised retroreflex	12
S50-PA-5-B01-PP	952001020	polarised retroreflex	12
S50-PA-5-C01-NN	952001510	long diffuse proximity	22
S50-PA-5-C01-PP	952001060	long diffuse proximity	22
S50-PA-5-C10-NN	952001520	short diffuse proximity	18
S50-PA-5-C10-PP	952001250	short diffuse proximity	18
S50-PA-5-C21-NN	952002190	midi diffuse proximity	20
S50-PA-5-C21-PP	952002180	midi diffuse proximity	20
S50-PA-5-D00-NN	952001530	fixed focus proximity	24
S50-PA-5-D00-PP	952001100	fixed focus proximity	24
S50-PA-5-E01-NN	952001540	fibre-optic amplifier	34
S50-PA-5-E01-PP	952001140	fibre-optic amplifier	34
S50-PA-5-F01-NN	952001550	receiver	2
S50-PA-5-F01-PP	952001160	receiver	2
S50-PA-5-G00-XG	952001200	emitter	2
S50-PA-5-M03-NN	952001560	background suppression	28
S50-PA-5-M03-PP	952001000	background suppression	28
S50-PA-5-T01-NN	952001580	retroreflex for transparents	16
S50-PA-5-T01-PP	952001270	retroreflex for transparents	16
S50-PA-5-U03-NN	952001590	luminescence sensor	38

PLASTIC FLAT HOUSING WITH AXIAL OPTICS			
MODEL	CODE N°	OPTIC FUNCTION	PAGE
S50-PA-5-U03-PP	952001310	luminescence sensor	38
S50-PA-5-W03-NN	952001600	contrast sensor	36
S50-PA-5-W03-PP	952001330	contrast sensor	36

PLASTIC FLAT HOUSING WITH RADIAL OPTICS			
MODEL	CODE N°	OPTIC FUNCTION	PAGE
S50-PR-2-B01-NN	952001780	polarised retroreflex	12
S50-PR-2-B01-PP	952001030	polarised retroreflex	12
S50-PR-2-C01-NN	952001790	long diffuse proximity	22
S50-PR-2-C01-PP	952001070	long diffuse proximity	22
S50-PR-2-C10-NN	952001800	short diffuse proximity	18
S50-PR-2-C10-PP	952001490	short diffuse proximity	18
S50-PR-2-D00-NN	952001810	fixed focus proximity	24
S50-PR-2-D00-PP	952001110	fixed focus proximity	24
S50-PR-2-F01-NN	952001820	receiver	2
S50-PR-2-F01-PP	952001170	receiver	2
S50-PR-2-G00-XG	952001210	emitter	2
S50-PR-2-T01-NN	952001830	retroreflex for transparents	16
S50-PR-2-T01-PP	952001280	retroreflex for transparents	16
S50-PR-5-B01-NN	952001720	polarised retroreflex	12
S50-PR-5-B01-PP	952001040	polarised retroreflex	12
S50-PR-5-C01-NN	952001730	long diffuse proximity	22
S50-PR-5-C01-PP	952001080	long diffuse proximity	22
S50-PR-5-C10-NN	952001740	short diffuse proximity	18
S50-PR-5-C10-PP	952001480	short diffuse proximity	18
S50-PR-5-D00-NN	952001750	fixed focus proximity	24
S50-PR-5-D00-PP	952001120	fixed focus proximity	24
S50-PR-5-F01-NN	952001760	receiver	2
S50-PR-5-F01-PP	952001180	receiver	2
S50-PR-5-G00-XG	952001220	emitter	2
S50-PR-5-T01-NN	952001770	retroreflex for transparents	16
S50-PR-5-T01-PP	952001290	retroreflex for transparents	16

PLASTIC FLAT HOUSING WITH LATERAL OPTICS			
MODEL	CODE N°	OPTIC FUNCTION	PAGE
S50-PS-2-M03-NN	952001900	background suppression	30
S50-PS-2-M03-PP	952001910	background suppression	30
S50-PS-5-M03-NN	952001920	background suppression	30
S50-PS-5-M03-PP	952001930	background suppression	30

PLASTIC FLAT HOUSING WITH LASER AXIAL OPTICS			
MODEL	CODE N°	OPTIC FUNCTION	PAGE
S50-PL-2-B01-NN	952001870	laser retroreflex	14
S50-PL-2-B01-PP	952001360	laser retroreflex	14
S50-PL-2-C01-NN	952001880	laser proximity	26
S50-PL-2-C01-PP	952001380	laser proximity	26
S50-PL-2-F01-NN	952001890	laser receiver	6
S50-PL-2-F01-PP	952001400	laser receiver	6
S50-PL-2-G00-XG	952001420	laser emitter	6
S50-PL-5-B01-NN	952001840	laser retroreflex	14
S50-PL-5-B01-PP	952001370	laser retroreflex	14
S50-PL-5-C01-NN	952001850	laser proximity	26
S50-PL-5-C01-PP	952001390	laser proximity	26
S50-PL-5-F01-NN	952001860	laser receiver	6
S50-PL-5-F01-PP	952001410	laser receiver	6
S50-PL-5-G00-XG	952001430	laser emitter	6

## MODEL SELECTION AND ORDER INFORMATION

PLASTIC FLAT HOUSING WITH LASER RADIAL OPTICS			
MODEL	CODE N°	OPTIC FUNCTION	PAGE
S50-PH-2-B01-NN	952001950	laser retroreflex	14
S50-PH-2-B01-PP	952001940	laser retroreflex	14
S50-PH-2-C01-NN	952001990	laser proximity	26
S50-PH-2-C01-PP	952001980	laser proximity	26
S50-PH-2-F01-NN	952002030	laser receiver	6
S50-PH-2-F01-PP	952002020	laser receiver	6
S50-PH-2-G00-XG	952002060	laser emitter	6
S50-PH-5-B01-NN	952001970	laser retroreflex	14
S50-PH-5-B01-PP	952001960	laser retroreflex	14
S50-PH-5-C01-NN	952002010	laser proximity	26
S50-PH-5-C01-PP	952002000	laser proximity	26
S50-PH-5-F01-NN	952002050	laser receiver	6
S50-PH-5-F01-PP	952002040	laser receiver	6
S50-PH-5-G00-XG	952002070	laser emitter	6

METAL CYLINDRICAL HOUSING WITH AXIAL OPTICS			
MODEL	CODE N°	OPTIC FUNCTION	PAGE
S50-MA-2-A00-NN	952022090	retroreflex	10
S50-MA-2-A00-PP	952022080	retroreflex	10
S50-MA-2-B01-NN	952021500	polarised retroreflex	12
S50-MA-2-B01-PP	952021000	polarised retroreflex	12
S50-MA-2-C01-NN	952021510	long diffuse proximity	22
S50-MA-2-C01-PP	952021010	long diffuse proximity	22
S50-MA-2-C10-NN	952021520	short diffuse proximity	18
S50-MA-2-C10-PP	952021020	short diffuse proximity	18
S50-MA-2-C21-NN	952022130	midi diffuse proximity	20
S50-MA-2-C21-PP	952022120	midi diffuse proximity	20
S50-MA-2-D00-NN	952021530	fixed focus proximity	24
S50-MA-2-D00-PP	952021030	fixed focus proximity	24
S50-MA-2-E01-NN	952021880	fibre-optic amplifier	34
S50-MA-2-E01-PP	952021040	fibre-optic amplifier	34
S50-MA-2-F01-NN	952021540	receiver	4
S50-MA-2-F01-PP	952021050	receiver	4
S50-MA-2-G00-XG	952021060	emitter	4
S50-MA-2-M03-NN	952021550	background suppression	28
S50-MA-2-M03-PP	952021070	background suppression	28
S50-MA-2-T01-NN	952021570	retroreflex for transparents	16
S50-MA-2-T01-PP	952021090	retroreflex for transparents	16
S50-MA-2-U03-NN	952021580	luminescence sensor	38
S50-MA-2-U03-PP	952021100	luminescence sensor	38
S50-MA-2-W03-NN	952021590	contrast sensor	36
S50-MA-2-W03-PP	952021110	contrast sensor	36
S50-MA-5-A00-NN	952022110	retroreflex	10
S50-MA-5-A00-PP	952022100	retroreflex	10
S50-MA-5-B01-NN	952021660	polarised retroreflex	12
S50-MA-5-B01-PP	952021200	polarised retroreflex	12
S50-MA-5-C01-NN	952021670	long diffuse proximity	22
S50-MA-5-C01-PP	952021210	long diffuse proximity	22
S50-MA-5-C10-NN	952021680	short diffuse proximity	18
S50-MA-5-C10-PP	952021220	short diffuse proximity	18

METAL CYLINDRICAL HOUSING WITH AXIAL OPTICS			
MODEL	CODE N°	OPTIC FUNCTION	PAGE
S50-MA-5-C21-NN	952022150	midi diffuse proximity	20
S50-MA-5-C21-PP	952022140	midi diffuse proximity	20
S50-MA-5-D00-NN	952021690	fixed focus proximity	24
S50-MA-5-D00-PP	952021230	fixed focus proximity	24
S50-MA-5-E01-NN	952021890	fibre-optic amplifier	34
S50-MA-5-E01-PP	952021240	fibre-optic amplifier	34
S50-MA-5-F01-NN	952021700	receiver	4
S50-MA-5-F01-PP	952021250	receiver	4
S50-MA-5-G00-XG	952021260	emitter	4
S50-MA-5-M03-NN	952021710	background suppression	28
S50-MA-5-M03-PP	952021270	background suppression	28
S50-MA-5-T01-NN	952021730	retroreflex for transparents	16
S50-MA-5-T01-PP	952021290	retroreflex for transparents	16
S50-MA-5-U03-NN	952021740	luminescence sensor	38
S50-MA-5-U03-PP	952021300	luminescence sensor	38
S50-MA-5-W03-NN	952021750	contrast sensor	36
S50-MA-5-W03-PP	952021310	contrast sensor	36

METAL CYLINDRICAL HOUSING WITH RADIAL OPTICS			
MODEL	CODE N°	OPTIC FUNCTION	PAGE
S50-MR-2-B01-NN	952021600	polarised retroreflex	12
S50-MR-2-B01-PP	952021140	polarised retroreflex	12
S50-MR-2-C01-NN	952021610	long diffuse proximity	22
S50-MR-2-C01-PP	952021150	long diffuse proximity	22
S50-MR-2-C10-NN	952021620	short diffuse proximity	18
S50-MR-2-C10-PP	952021490	short diffuse proximity	18
S50-MR-2-D00-NN	952021630	fixed focus proximity	24
S50-MR-2-D00-PP	952021160	fixed focus proximity	24
S50-MR-2-F01-NN	952021640	receiver	4
S50-MR-2-F01-PP	952021170	receiver	4
S50-MR-2-G00-XG	952021180	emitter	4
S50-MR-2-T01-NN	952021650	retroreflex for transparents	16
S50-MR-2-T01-PP	952021190	retroreflex for transparents	16
S50-MR-5-B01-NN	952021760	polarised retroreflex	12
S50-MR-5-B01-PP	952021340	polarised retroreflex	12
S50-MR-5-C01-NN	952021770	long diffuse proximity	22
S50-MR-5-C01-PP	952021350	long diffuse proximity	22
S50-MR-5-C10-NN	952021780	short diffuse proximity	18
S50-MR-5-C10-PP	952021480	short diffuse proximity	18
S50-MR-5-D00-NN	952021790	fixed focus proximity	24
S50-MR-5-D00-PP	952021360	fixed focus proximity	24
S50-MR-5-F01-NN	952021800	receiver	4
S50-MR-5-F01-PP	952021370	receiver	4
S50-MR-5-G00-XG	952021380	emitter	4
S50-MR-5-T01-NN	952021810	retroreflex for transparents	16
S50-MR-5-T01-PP	952021390	retroreflex for transparents	16

## MODEL SELECTION AND ORDER INFORMATION

METAL CYLINDRICAL HOUSING WITH LATERAL OPTICS			
MODEL	CODE N°	OPTIC FUNCTION	PAGE
S50-MS-2-M03-NN	952021900	background suppression	30
S50-MS-2-M03-PP	952021910	background suppression	30
S50-MS-5-M03-NN	952021920	background suppression	30
S50-MS-5-M03-PP	952021930	background suppression	30

METAL CYLINDRICAL HOUSING WITH LASER AXIAL OPTICS			
MODEL	CODE N°	OPTIC FUNCTION	PAGE
S50-ML-2-B01-NN	952021820	laser retroreflex	14
S50-ML-2-B01-PP	952021400	laser retroreflex	14
S50-ML-2-C01-NN	952021830	laser proximity	26
S50-ML-2-C01-PP	952021410	laser proximity	26
S50-ML-2-F01-NN	952021840	laser receiver	8
S50-ML-2-F01-PP	952021420	laser receiver	8
S50-ML-2-G00-XG	952021430	laser emitter	8
S50-ML-5-B01-NN	952021850	laser retroreflex	14
S50-ML-5-B01-PP	952021440	laser retroreflex	14
S50-ML-5-C01-NN	952021860	laser proximity	26
S50-ML-5-C01-PP	952021450	laser proximity	26
S50-ML-5-F01-NN	952021870	laser receiver	8
S50-ML-5-F01-PP	952021460	laser receiver	8
S50-ML-5-G00-XG	952021470	laser emitter	8

METAL CYLINDRICAL HOUSING WITH LASER RADIAL OPTICS			
MODEL	CODE N°	OPTIC FUNCTION	PAGE
S50-MH-2-B01-NN	952021940	laser retroreflex	14
S50-MH-2-B01-PP	952021950	laser retroreflex	14
S50-MH-2-C01-NN	952021990	laser proximity	26
S50-MH-2-C01-PP	952021980	laser proximity	26
S50-MH-2-F01-NN	952022030	laser receiver	8
S50-MH-2-F01-PP	952022020	laser receiver	8
S50-MH-2-G00-XG	952022060	laser emitter	8
S50-MH-5-B01-NN	952021970	laser retroreflex	14
S50-MH-5-B01-PP	952021960	laser retroreflex	14
S50-MH-5-C01-NN	952022010	laser proximity	26
S50-MH-5-C01-PP	952022000	laser proximity	26
S50-MH-5-F01-NN	952022050	laser receiver	8
S50-MH-5-F01-PP	952022040	laser receiver	8
S50-MH-5-G00-XG	952022070	laser emitter	8

## MODEL CODING TABLE

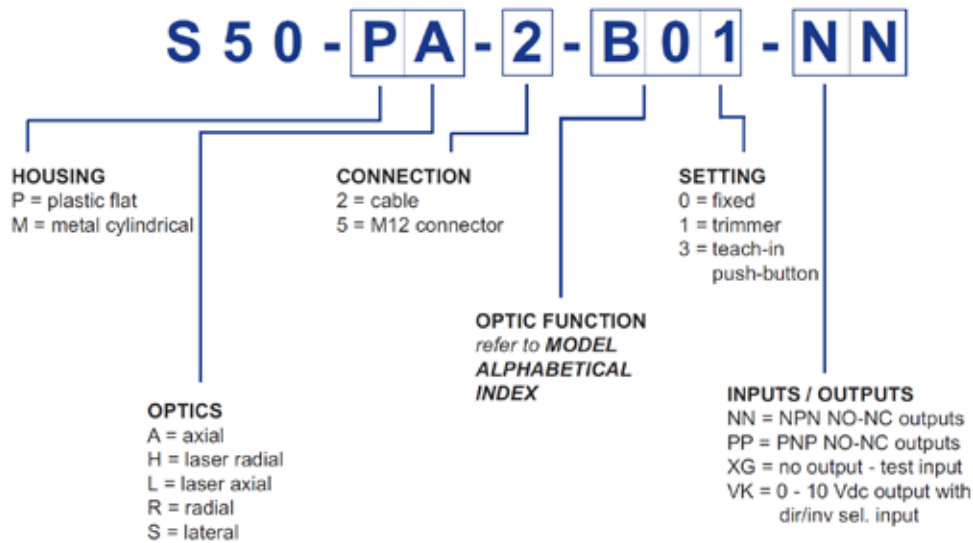

**Note:** Not all code combinations are available. Please refer to alphabetical model index for the list of available models.



**CONNECTRIC  
SYSTEMS INC.**

28-207 Edgeley Blvd., Concord, Ontario, L4K 4B5  
 Ph: 905-669-0080      Fax: 905-669-0082  
 www.connectric.com      info@connectric.com

The company endeavours to continuously improve and renew its products; for this reason the technical data and contents of this catalogue may undergo variations without prior notice. For correct installation and use, the company can guarantee only the data indicated in the instruction manual supplied with the products.